

- FILE CABINET LOCKS
- METAL DESK LOCKS
- VENDING MACHINES
- FLUSH HANDLE CYLINDERS

- DRAWER AND DOOR LOCKS
- SWITCH LOCKS
- SLIDING DOOR LOCKS

FILE CABINET LOCKS 4-PIN TUMBLER

Satin Chrome. Furnished with 2 keys per lock.
Available Keyed alike(KA) or Keyed Different(KD)

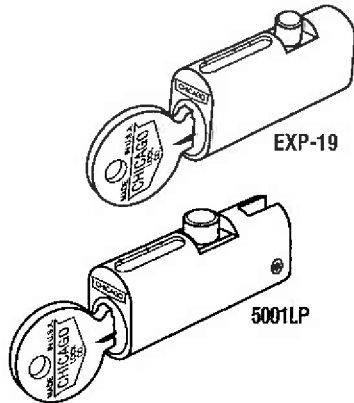

CHCEXP-19DC 14²⁰ ea.
Die Cast Cylinder-
Round Die Cast Bolt- Brass Keys.

CHC5001-LP 14⁴² ea.
Die Cast Cylinder-
Heavy Round Brass Bolt-Brass Keys

CHC5002-LP 13⁹⁰ ea.
Die Cast Cylinder-
Heavy Rectangular Brass Bolt-Brass
Keys (Not Pictured)

ACE® FLUSH HANDLE CYLINDER

CHC4255-19RL

14⁷⁵ ea.

Replacement cylinder for flush handle.
Easily removed by depressing spring bolt
when in unlocked position, for quick
change of key combination.
Standard ACE® Cylinder. Chrome finish.

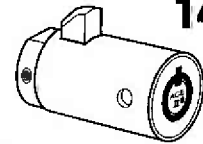

SLIDING DOOR LOCK

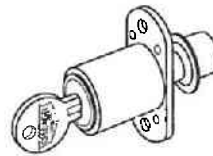

CHC1770
18¹² ea.

5 Disc Tumblers. Can be keyed to any
Chicago Lock 5-Disc tumbler single bitted
lock. Has a spring bolt which is locked by
pushing the cylinder in, and released by a
key turning motion.
Satin Chrome finish.

ACE® SCREW TYPE LOCK FOR COIN METERS and VENDING MACHINES

CHCSA4107
21⁰⁸ ea.

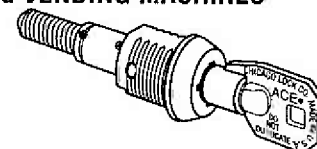

For drawing doors and covers down tight on coin meters and vending machines.
ACE 7 pin tumbler. Steel, 5/16" x 18 or 5/16" x 24 threaded extensions. Extensions
can be furnished in special lengths, threaded to special requirements. Standard with
two flats - 5/8" across. Provided with two tubular type keys.
Cylinder; 3/4" x 27 thread. Polished Nickel finish

DOUBLE BITTED SWITCH LOCKS

Single Pole, Single Throw 11-blade criss cross tumblers. 3/4"-27 threaded
cylinder. Dependable wiping contacts. Furnished standard with milled flat. .700"
barrel. Available Keyed Alike(KA) or Keyed Different(KD) Polished Chrome finish.

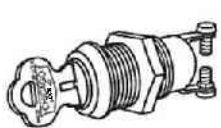

MOMENTARY CONTACT SWITCH

Makes no contact when key is out (locked position).
Once key is inserted and rotated 90° clockwise, momen-
tary contact is made, and the built-in spring automati-
cally returns the switch to off as key is released.

Code	Key Removable in:	With Key Out	Terminals	Contact	Price/Ea.
CHC2174-700C	Off Position	Contact is Open	Screw	Maintaining	17.12

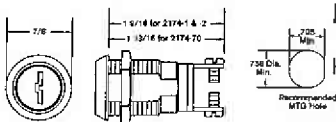

Maintaining Contact Switch

Makes contact in open position only.
Key can be removed in On or Off position.

Code	Key Removable in:	With Key Out	Terminals	Contact	Price/Ea.
CHC2174-2DC	Off and On Positions	Contact is Open-Closed	Screw	Maintaining	14.55

SURFACE MOUNTED DRAWER LOCKS

Solid one-piece die cast case. 5 disc tumblers. Die cast 7/8" diameter. 180° key turn;
key withdraws in both locked and unlocked positions. Provided with two brass keys per
lock.

Available Keyed Alike (KA) or Keyed Different (KD). Dull Brass finish.

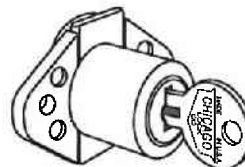

CHC1968 11.54 ea.
7/8" thickness of wood

DRAWER AND DOOR LOCK

Single bitted die cast lock with a 3/4" diameter cylinder. Furnished with a 90° key
rotation with the key removing in both the locked and unlocked positions. Designed
for use in conjunction with latching mechanism. Dull Nickel finish.



CH1725-6TNH 9.17 ea.

DRAWER AND DOOR LOCKS WITH REMOVABLE BOLT AND PLUG FOR MOUNTING IN HOLLOW METAL

A convenient system of drawer and door locks for
metal furniture. Easy assembly and disassembly in just
a few minutes. Available Keyed Alike (KA) or Keyed
Different (KD). Satin Chrome finish.

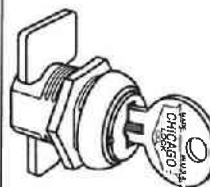

CATALOG NUMBER	A	B	C	D	LAMINATED STEEL AND DIE CAST BOLT OR BRASS BOLT	PRICE EACH
CHC1974	18/32	25/32	3/4	33/64	11/64 X 11/64 throw	8.20
CHC1975	21/32	19/16	3/4	5/16	5/8 X 5/32 throw	8.51

T-HANDLE ASSEMBLY FOR LIMITED SPACE

- Accepts Ace II® cylinder 4260-19
- Standard Finish: Chrome
- Customer must furnish "A" and "B" dimension

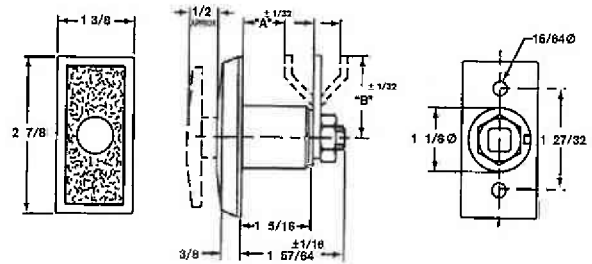
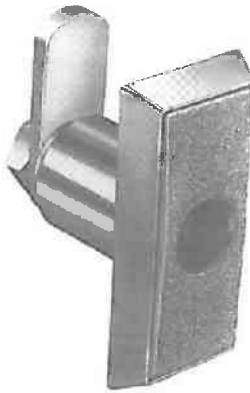

CHOU-4260
34²⁰

Handle and cylinder dimensions do not conform to NAMA standards.

**4200 SERIES
RETROFITS OU-4260 & OU-5560 "T" HANDLES**

- Increased security for limited spaces
- Accepts standard and long cylinder locks which meet NAMA dimensional standards
- Available 90° or 180° rotation
- Textured finish for scratch resistance. Standard finish - Chrome

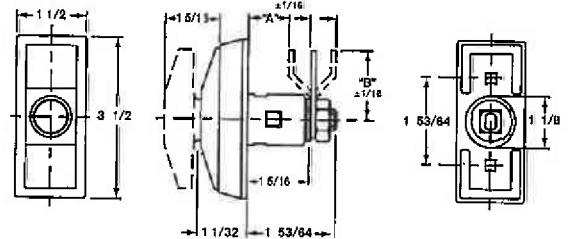

CHOU-4200-NA
29⁵⁰

**STANDARD SCREW TYPE
Easily Tighten Door Without Losing Seal**

- When fully extended, handle is free wheeling to 360°
- When partially depressed, handle is free wheeling to 120°
- Furnished with 1/2 x 13 threaded stud
- Front design has built up flange and tapered "T" handle construction
- Accepts standard and long cylinders which meet NAMA dimensional standards
- Textured finish for scratch resistance. Standard finish - Chrome
- Customer must specify "A" dimension

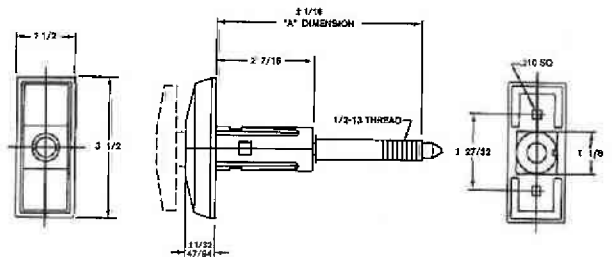

CHOU-4265
36⁷⁰

• CAM LOCKS

ACE II® PIN TUMBLER CAM LOCKS

Patented ACE II® lock assembly in 3/4" dia. brass barrel with two flats 5/8" across. Key and cam rotation 90° & 180° with keypull at 12 O'Clock & 3 O'Clock. Cams furnished are 1/8" thick x 3/4" wide, flat and a 1/4" offset. Polished nickel plating. Two keys furnished per lock. 10 locks per pack. KD/KA



Code	"D"	"B"	"C"	Price
CHC4153	11/16"	1 1/8"	1/4"	15.59
CHC4152	15/16"	1 1/8"	13/64"	16.29
CHC4160	1 3/32"	1 1/8"	13/64"	16.19
CHC4198	19/32"	1 1/8"	23/64"	15.65

ACE II® SWITCH LOCK
Single Pole, Double Throw

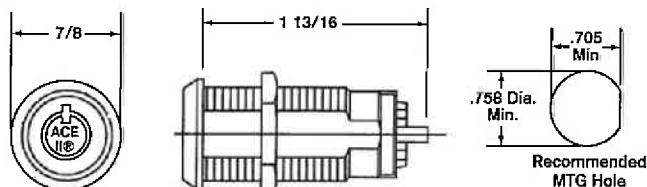
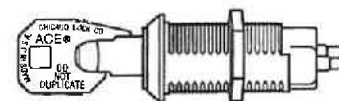

- Maintaining contact switch operated by manually rotating inserted key 90° clockwise from open to closed position
- Momentary contact switch locks feature spring return from closed to open position after 90° clockwise key rotation to closed position
- Switches are UL Recognized
- Standard finish - Bright Chrome
- Two keys are furnished per lock

Code	Keypull	Contact	Price
CHC4073-1DC	OFF Only	Maintaining	18.26
CHC4073-2DC	OFF & ON	Maintaining	18.26
CHC4073-70DC	OFF Only	Momentary	21.08

SINGLE BITTED CAM LOCKS

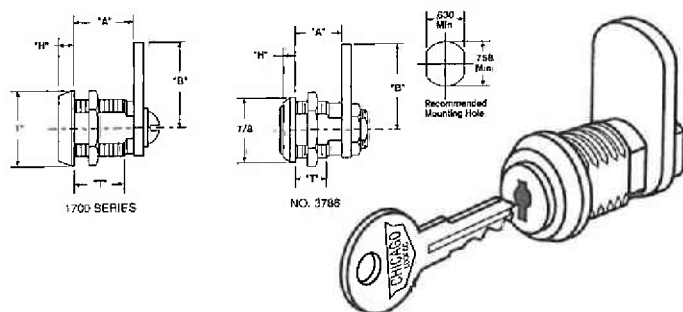

- Five disc tumbler plug in 3/4" diameter
- Die cast barrel with two flats - 5/8" across
- Key and cam rotation 90° from locked (12 O'Clock) to unlocked (3 O'Clock) position with keypull in locked position only
- Straight cam furnished is 1/8" thick x 3/4" wide
- Standard finish - Polished Nickel Plate
- Two keys furnished per lock
- Available KA or KD

Code	"A"	"B"	"H"	"T"	Price
CHC3705	7/16"	1 1/8"	1/4"	13/64"	11.15
CHC3786	5/8"	1 1/8"	13/64"	13/32"	8.13
CHC1701	13/16"	1 1/8"	13/64"	11/16"	10.88
CHC1702	1 1/16"	1 1/8"	13/64"	15/16"	11.68
CHC1703	1 3/16"	1 1/8"	13/64"	1 7/64"	10.09
CHC1704	1 1/2"	1 1/8"	13/64"	1 13/32"	10.75

DOUBLE BITTED CAM LOCKS

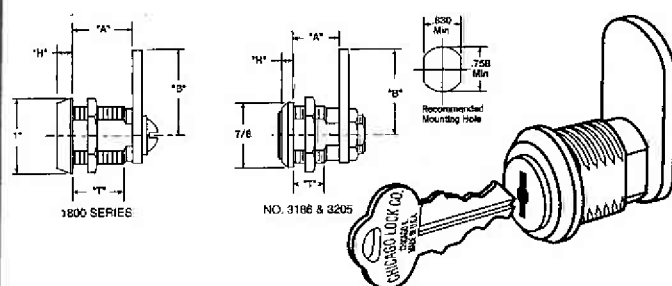

- Eleven criss-cross blade tumbler plug in 3/4" diameter
- Die cast barrel with two flats - 5/8" across
- Key and cam rotation 90° from locked (12 O'Clock) to unlocked (3 O'Clock) position with keypull in locked position only
- Straight cam furnished is 1/8" thick x 3/4" wide
- Standard finish - Polished Nickel Plate
- Two keys furnished per lock
- Available KA or KD

Code	"A"	"B"	"H"	"T"	Price
CHC3205	7/16"	1 1/8"	13/64"	15/64"	14.43
CHC3186	5/8"	1 1/8"	5/32"	13/32"	10.05
CHC1801	13/16"	1 1/8"	13/64"	11/16"	13.06
CHC1802	1 1/16"	1 1/8"	13/64"	15/16"	13.22
CHC1803	1 3/16"	1 1/8"	13/64"	1 7/64"	13.22
CHC1804	1 1/2"	1 1/8"	13/64"	1 13/32"	14.02

SERVICE KITS



Ace® Locking Cams Service Kit
Part No. 99629



Ace® Tumbler Service Kit
Part No. 99630

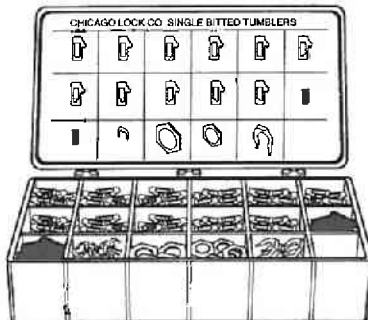

Single Bitted Service Kit
Part No. 99094-000

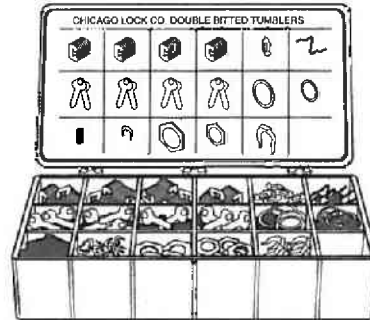

Double Bitted Service Kit
Part No. 99095-000

Ace Locking Cams Service Kit
CHD9629

123.06

Ace Tumbler Service Kit
CHD9630

111.15

Single Bitted Service Kit
CHD9094

71.45

Double Bitted Service Kit
CHD9095

83.99

ACE II® KEY HANDLE COVERS

Made of durable, strong plastic that will press fit any ACE II® key. Larger size allows for better grip. Adds extra profit to every sale.

Package of 5
3⁵⁵/pack

NEW!
Ace II® Key Handle Covers
Specify Color By Product No.



Code	Color
CHD9645	Turquoise
CHD9646	Yellow
CHD9647	Orange
CHD9648	Green
CHD9649	White
CHD9650	Blue
CHD9651	Purple
CHD9652	Tan
CHD9653	Brown
CHD9654	Maroon

WEATHER COVER

Protect switch locks and cam locks from the elements with this economical, easy to install weather cover.

Quality construction includes:

- Chrome plated zinc die cast cover
- Stainless steel mounting ring
- Permanently installed rubber seal
- Positive spring closure to insure seal integrity.

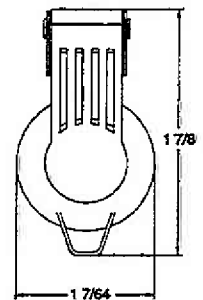
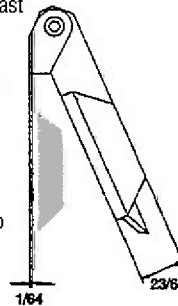

CHD9655-WC
5/pk
7⁵¹ ea pc.



KEYLOC
ACE II PATENTED

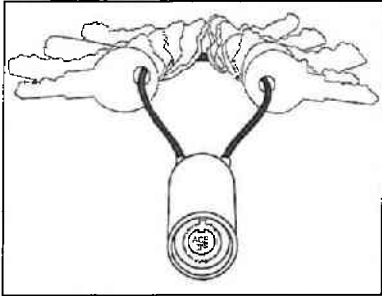

- Vinyl coated steel cables—the same used in the aircraft industry—resistant to cutting. If cut, cable is non-repairable.
- Cables are available in 3 sizes: 4", 6" and 9" loops. Key ring loops hold 10 to 50 keys.
- Retainer pins fit securely into patented ACEII® Cylinder nested in lightweight aluminum housing.
- Easy 1/4 turn cable installation.
- Supplied with 2 keys, security seal and scratch resistant vinyl cover.

KD/KA

P/N	Loop	Retail
CHC4201-4	4"	44.97
CHC4201-6	6"	46.53
CHC4201-9	9"	47.22

Wire Loop Only

CHC4201-5A	4"	19.40
CHC4201-5B	6"	20.10

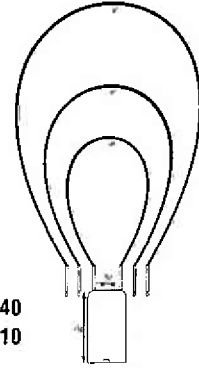

STEELCASE® REPLACEMENT FRONT REMOVABLE PLUGS

ORIGINAL PATENTED PARTS AVAILABLE FROM CHICAGO LOCK

- 6 disc tumbler construction easily rekeyable with 99094-000 service kit
- For added security, removal tool will function only in the unlocked position

COMPLETE PLUG ASSEMBLY

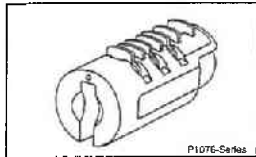

PLUG-SUB ASSEMBLY
(Retaining Tumblers Only)

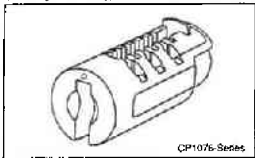

CHP-1076-KA Coded Plug w/2 keys, KA **11.00**
CHP-1076-KD Coded Plug w/2 keys, KD **10.20**

CHK100RK68 Removal Tool **5.80**

PADLOCKS

- Removeable core and shackle
- Extruded brass body
- Hardened steel shackles to resist cutting and sawing
- ACE II® patented assembly process locking mechanism.
- 7 pin tubular lock with 2 keys
- Self locking

40mm PADLOCK

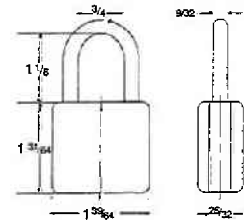
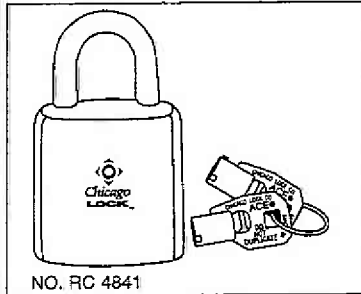

CHRC4841

3775

50mm PADLOCK

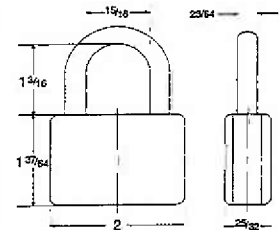
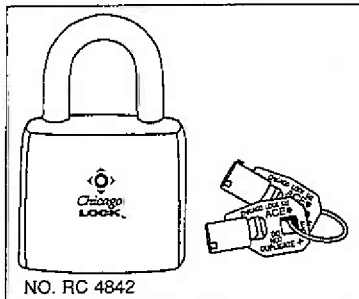

CHRC4842

3933

• KEYBLANKS

SINGLE BITTED

For 6-Blade Tumbler Locks

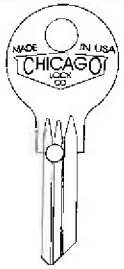

K-100-MH
6-Tumbler
CHDK-100MH
86¢

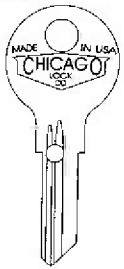

K-101-H
6-Tumbler
CHDK-101H
86¢

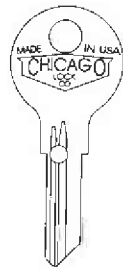

K-102-H
6-Tumbler
CHDK-102H
86¢

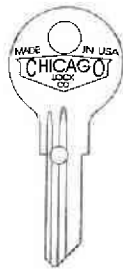

K-103-G
6-Tumbler
CHDK-103G
1.07

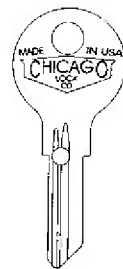

K-103-H
6-Tumbler
CHDK-103H
86¢

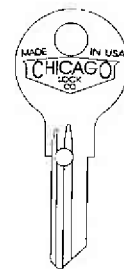

K-104-H
6-Tumbler
CHDK-104H
86¢



K-501
5-Tumbler
CHDK-501
86¢



K-502
5-Tumbler
CHDK-502
86¢

PIN TUMBLER BLANKS

For 5-Pin Tumbler Locks

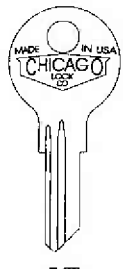

K-503
5-Tumbler
CHDK-503
86¢

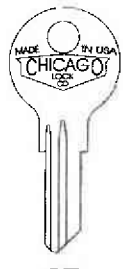

K-504
5-Tumbler
CHDK-504
1.01

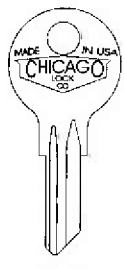

K-5
5-Tumbler
CHDK-5
77¢



K-9
5-Tumbler
CHDK-9
77¢



K-P-12
5-PinTumbler
CHDKP-12
82¢

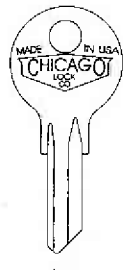

K-35
5-Tumbler
CHDK-35
77¢

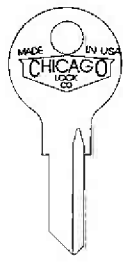

K-35-M
5-Tumbler
CHDK-35M
77¢

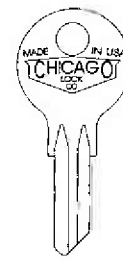

K-38
5-Tumbler
CHDK-38
77¢

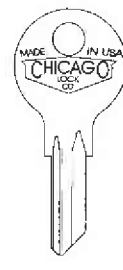

K-39
5-Tumbler
CHDK-39
77¢

PIN TUMBLER BLANKS

For 4-Pin Tumbler Locks



K-P-1

4-Pin Tumbler

CHDKP-1
82¢



K-P-2

4-Pin Tumbler

CHDKP-2
82¢



K-P-3

4-Pin Tumbler

CHDKP-3
82¢



K-P-4

4-Pin Tumbler

CHDKP-4
82¢

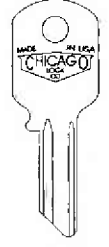

K-P-9

4-Pin Tumbler

CHDKP-9
86¢

DOUBLE BITTED



K-4-L

Off Center Left

CHDK-4L
77¢



K-4

Center Groove

CHDK-4
Center Groove
77¢



K-4-R

Off Center Right

CHDK-4R
77¢



K-4-W

"W" Milling

CHDK-4W
77¢



K-2-W

"W" Milling

CHDK-2W
86¢



K-2

Center Groove

CHDK-2
Center Groove
86¢



K-18

Thicker Blank

CHDK-18
95¢

GENUINE CHICAGO ACE KEYBLANKS

For ACE® and ACE II® locks
50 per pack.

CHD137-CLC
1.01



ACE® & ACE II®
Keyblank

ACE® KEY HOLDER

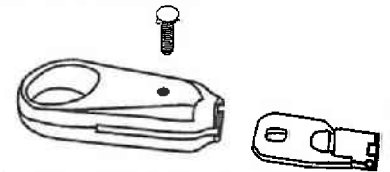

- Large, "user-friendly" ACE® Key Holder allows better grip and overall control of key
- Fasten any ACE® Key to holder with 8-32 semi screw (included with holder).

CHD2905
18⁷⁶