

• KNOBSETS

HEAVY DUTY CYLINDRICAL LOCKSETS - SERIES CK4200

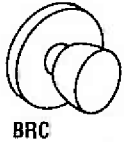

BRC

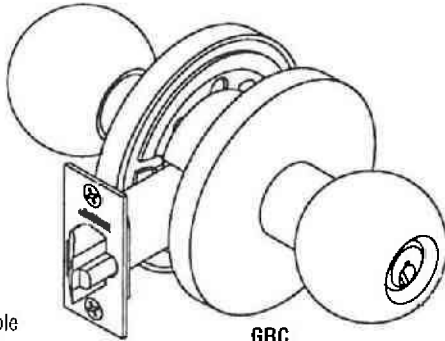

GRC

10/case.

Standard Features-

- Handing - Field Reversible
- Door Thickness - 1 3/4"-2"
- Backset - 2 3/4"
- Strike - ANSI curved lip 4 7/8" x 1 1/4" x 1 1/4" lip to center
- Cylinder - Brass, 6-pin L4 keyway
- Keys - Two nickel silver keys

Code	Finish	Price
------	--------	-------

PASSAGE

CRCK4210-612	Satin Bronze	386.00
CRCK4210-626	Satin Chrome	386.00
CRCK4210-605	Polish Brass	406.00

BATH/BEDROOM

CRCK4220-612	Satin Bronze	442.00
CRCK4220-626	Satin Chrome	442.00
CRCK4220-605	Polished Brass	462.00

CLASSROOM

CRCK4255-612	Satin Bronze	500.00
CRCK4255-626	Satin Chrome	500.00
CRCK4255-605	Polished Brass	520.00

ENTRANCE

CRCK4251-612	Satin Bronze	500.00
CRCK4251-626	Satin Chrome	500.00
CRCK4251-605	Polished Brass	520.00

EXTERIOR

CRCK4282-612	Satin Bronze	547.00
CRCK4282-626	Satin Chrome	547.00
CRCK4282-605	Polished Brass	567.00

STOREROOM

CRCK4257-612	Satin Bronze	500.00
CRCK4257-626	Satin Chrome	500.00
CRCK4257-605	Polished Brass	520.00

STANDARD DUTY CYLINDRICAL LOCKSETS - SERIES CK4400

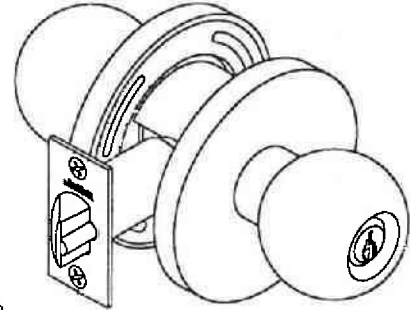

20/case.

Standard Features-

- Handing - Field Reversible
- Door Thickness - 1 3/8"-1 3/4"
- Backset - 2 3/4"
- Strike - ANSI curved lip 4 7/8" x 1 1/4" x 1 1/4" lip to center
- Cylinder - Brass, 6 pin L4 keyway
- Keys - Two nickel silver keys

Code	Finish	Price
------	--------	-------

PASSAGE

CRCK4410GWC-605	Polished Brass	118.00
CRCK4410GWC-612	Satin Bronze	118.00
CRCK4410GWC-630	Satin Stainless Steel	124.00

BATH/BEDROOM

CRCK4430GWC-605	Polished Brass	134.00
CRCK4430GWC-612	Satin Bronze	134.00
CRCK4430GWC-630	Satin Stainless Steel	140.00

CLASSROOM

CRCK4455GWC-605	Polished Brass	180.00
CRCK4455GWC-612	Satin Bronze	180.00
CRCK4455GWC-630	Satin Stainless Steel	180.00

ENTRANCE

CRCK4451GWC-605	Polished Brass	180.00
CRCK4451GWC-612	Satin Bronze	180.00
CRCK4451GWC-630	Satin Stainless Steel	180.00

STORE DOOR

CRCK4482GWC-605	Polished Brass	227.00
CRCK4482GWC-612	Satin Bronze	227.00
CRCK4482GWC-630	Satin Stainless Steel	227.00

STOREROOM

CRCK4457GWC-605	Polished Brass	180.00
CRCK4457GWC-612	Satin Bronze	180.00
CRCK4457GWC-630	Satin Stainless Steel	180.00

EXTRA HEAVY DUTY CYLINDRICAL LOCKSET SERIES CL3300

Standard Features-

- Handing - Non Handed
- Door Thickness - 1 3/4"-2 1/4"
- Backset - 2 3/4"
- Strike - ANSI curved lip 4 7/8" x 1 1/4" x 1 1/4" lip to center
- Cylinder - Brass, 6-pin L4 keyway (other keyways in stock, including IC)
- Keys - Two nickel silver keys

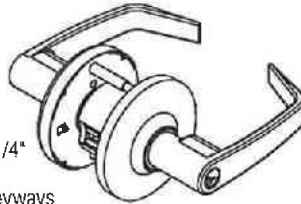

6/case

- | | |
|-----|----------------------------|
| 605 | Bright Brass |
| 606 | Satin Brass |
| 612 | Satin Bronze |
| 613 | Dark Oxidized Satin Bronze |
| 625 | Bright Chromium Plated |
| 626 | Satin Chromium Plated |

Lever: Die cast zinc Rose: Wrought



Code	606, 612, 626	605, 613, 625
PASSAGE		
CRCL3310	308.00	318.00
PRIVACY		
CRCL3320	354.00	364.00
INSTITUTION		
CRCL3332	459.00	469.00
HALF DUMMY		
CRCL3350	151.00	156.00
ENTRANCE		
CRCL3351	412.00	422.00
CLASSROOM		
CRCL3355	412.00	422.00
STOREROOM		
CRCL3357	412.00	412.00
FULL DUMMY		
CRCL3370	254.00	264.00

INTERCHANGEABLE CORE - 6 PIN

Code	606, 612, 626	605, 613, 625
ENTRANCE		
CRCL3351-C6	456.00	466.00
CLASSROOM		
CRCL3355-C6	456.00	466.00
STOREROOM		
CRCL3357-C6	456.00	466.00

ELECTRIFIED - NZD ONLY

Code	626 ONLY	605, 612, 626
FAIL SAFE		
CRCL33903	618.00	628.00
FAIL SECURE		
CRCL33905	618.00	628.00

HEAVY DUTY CYLINDRICAL LEVER LOCKSET CL3500/3600 SERIES (3600 will be discontinued)

Standard Features-

- Handing - Non handed
- Door Thickness - 1 3/8"-1 3/4"
- Backset - 2 3/4"
- Strike - ANSI curved lip 4 7/8" x 1 1/4" x 1 1/4" lip to center
- Cylinder - Brass, 6 pin L4 keyway
- Keys - Two nickel silver keys

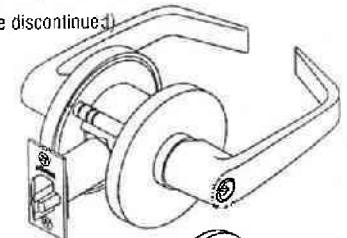

NZD

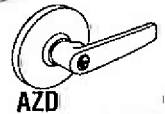

6/case.

- | | |
|-----|----------------|
| 605 | Bright Brass |
| 612 | Satin Bronze |
| 626 | Satin Chromium |

Code	612, 626	605
PASSAGE		
CRCL3510	270.00	280.00
PRIVACY		
CRCL3520	298.00	308.00
ENTRANCE		
CRCL3551	352.00	362.00
CLASSROOM		
CRCL3555	352.00	362.00
STOREROOM		
CRCL3557	352.00	362.00

STANDARD DUTY GRADE 2 LEVER LOCKSETS - SERIES CL3800/3900 (3900 will be discontinued)

Standard Features-

- Handing - Field Reversible
- Door Thickness - 1 3/8"-1 3/4"
- Backset - 2 3/4" standard
- Strike - ANSI curved lip 4 7/8" x 1 1/4" x 1 1/4" lip to center
- Cylinder - Brass, 6 pin L4 keyway, 0 Bitted
- Keys - Two nickel silver keys
- Free Wheeling Lever

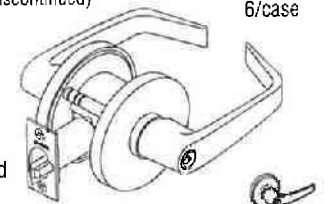

NZD

AZD

6/case

Code	626	605, 612, 626
PASSAGE		
CRCL3810	192.00	200.00
PRIVACY BATH/BEDROOM		
CRCL3820	212.00	220.00
HALF DUMMY		
CRCL3850	110.00	114.00
ENTRANCE		
CRCL3851	260.00	268.00
CLASSROOM		
CRCL3855	260.00	268.00
STOREROOM		
CRCL3857	260.00	268.00

MORTISE LOCKSET ML2000 SERIES

Standard Features-

- Handing - Field Reversible
- Door Thickness - 1 3/4"
- Backset - 2 3/4"
- Strike - ANSI straight lip 4 7/8" x 1 1/4" x 1 1/8" lip to center
- Cylinder - Brass, 6 pin L4 keyway
- Keys - Two nickel silver keys

Functions-

- 2010 - Passage or Closet
- 2020 - Privacy
- 2022 - Store Door
- 2030 - Privacy Bedroom or Bathroom
- 2048 - Entrance or Apartment
- 2050 - Half Dummy Trim
- 2051 - Entrance or Office
- 2055 - Classroom
- 2057 - Storeroom or Closet
- 2067 - Apartment or Dormitory
- 2070 - Full Dummy Trim

Deadbolt only on
2020
2022
2030
2048
2067
functions

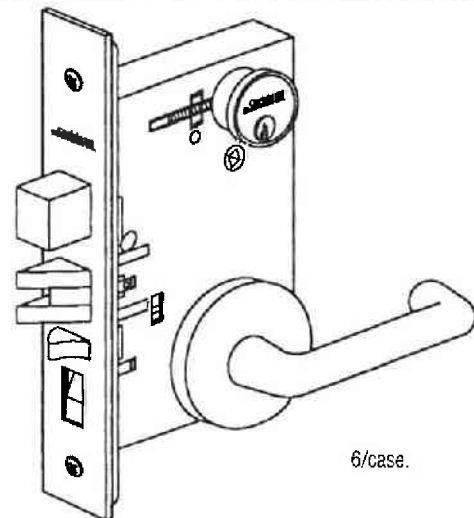

6/case.

Finishes:

- 605 - Bright brass
- 606 - Satin brass
- 612 - Satin bronze
- 613 - Dark oxidized satin bronze
- 625 - Bright chromium plated
- 626 - Satin chromium plated
- 630 - Satin stainless steel

ASA

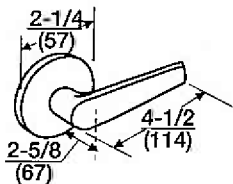

Lever: Cast
Rose: Wrought

Code	612, 625, 626	605, 606, 613	630
CRML2010ASA	494.00	502.00	512.00
CRML2020ASA	550.00	558.00	568.00
CRML2022ASA	636.00	644.00	654.00
CRML2030ASA	550.00	558.00	568.00
CRML2048ASA	603.00	611.00	621.00
CRML2050ASA	202.00	206.00	211.00
CRML2051ASA	583.00	591.00	601.00
CRML2055ASA	583.00	591.00	601.00
CRML2057ASA	583.00	591.00	601.00
CRML2067ASA	603.00	611.00	621.00
CRML2070ASA	404.00	412.00	422.00

RWA

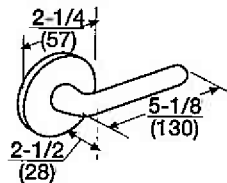

Knob: Wrought, reinforced
Rose: Wrought, reinforced

Code	612, 630	605, 606, 613, 626	625
CRML2010RWA	393.00	401.00	411.00
CRML2020RWA	447.00	455.00	465.00
CRML2022RWA	533.00	541.00	551.00
CRML2030RWA	447.00	455.00	465.00
CRML2048RWA	500.00	508.00	518.00
CRML2050RWA	150.50	154.50	159.50
CRML2051RWA	480.00	488.00	498.00
CRML2055RWA	480.00	488.00	498.00
CRML2057RWA	480.00	488.00	498.00
CRML2067RWA	500.00	508.00	518.00
CRML2070RWA	301.00	309.00	319.00

NSA

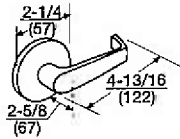

Lever: Cast
 Rose: Wrought

Code	612, 625, 626	605, 606, 613	630
CRML2010NSA	494.00	502.00	512.00
CRML2020NSA	550.00	558.00	568.00
CRML2022NSA	636.00	644.00	654.00
CRML2030NSA	550.00	558.00	568.00
CRML2048NSA	603.00	611.00	621.00
CRML2050NSA	202.00	206.00	211.00
CRML2051NSA	583.00	591.00	601.00
CRML2055NSA	583.00	591.00	601.00
CRML2057NSA	583.00	591.00	601.00
CRML2067NSA	603.00	611.00	621.00
CRML2070NSA	404.00	412.00	422.00

NSM

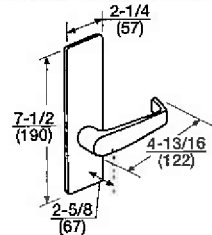

Lever: Cast
 Escutcheon: Wrought

Code	612, 625, 626	605, 606, 613	630
CRML2010NSM	502.00	510.00	520.00
CRML2020NSM	558.00	566.00	576.00
CRML2022NSM	644.00	652.00	662.00
CRML2030NSM	558.00	566.00	576.00
CRML2048NSM	611.00	619.00	629.00
CRML2050NSM	206.00	210.00	215.00
CRML2051NSM	591.00	599.00	609.00
CRML2055NSM	591.00	599.00	609.00
CRML2057NSM	591.00	599.00	609.00
CRML2067NSM	611.00	619.00	629.00
CRML2070NSM	412.00	420.00	430.00

GRC

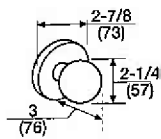

Knob: Wrought, reinforced
 Rose: Wrought, reinforced

Code	612, 625, 626	605, 606, 613	630
CRML2010GRC	530.00	538.00	548.00
CRML2020GRC	595.00	603.00	613.00
CRML2022GRC	681.00	689.00	699.00
CRML2030GRC	595.00	603.00	613.00
CRML2048GRC	648.00	656.00	666.00
CRML2050GRC	216.00	220.00	225.00
CRML2051GRC	628.00	636.00	646.00
CRML2055GRC	628.00	636.00	646.00
CRML2057GRC	628.00	636.00	646.00
CRML2067GRC	648.00	656.00	666.00
CRML2070GRC	432.00	440.00	450.00

GRM

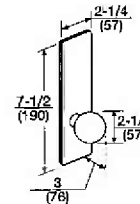

Knob: Wrought, reinforced
 Escutcheon: Wrought

Code	612, 625, 626	605, 606, 613	630
CRML2010GRM	554.00	562.00	572.00
CRML2020GRM	619.00	627.00	637.00
CRML2022GRM	705.00	713.00	723.00
CRML2030GRM	619.00	627.00	637.00
CRML2048GRM	672.00	680.00	690.00
CRML2050GRM	228.00	232.00	237.00
CRML2051GRM	652.00	660.00	670.00
CRML2055GRM	652.00	660.00	670.00
CRML2057GRM	652.00	660.00	670.00
CRML2067GRM	672.00	680.00	690.00
CRML2070GRM	456.00	464.00	474.00

LWA

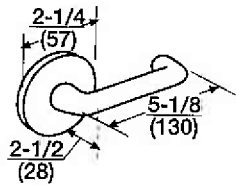

Lever: Wrought
Rose: Wrought

Code	612, 630	605, 606, 613, 626	625
CRML201DLWA	393.00	401.00	411.00
CRML202DLWA	447.00	455.00	465.00
CRML2022LWA	533.00	541.00	551.00
CRML2030LWA	447.00	455.00	465.00
CRML2048LWA	500.00	508.00	518.00
CRML2050LWA	150.50	154.50	159.50
CRML2051LWA	480.00	488.00	498.00
CRML2055LWA	480.00	488.00	498.00
CRML2057LWA	480.00	488.00	498.00
CRML2067LWA	500.00	508.00	518.00
CRML2070LWA	381.00	309.00	319.00

LWM

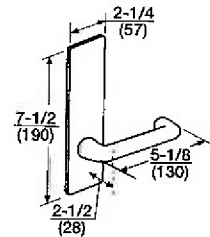

Lever: Wrought
Escutcheon: Wrought

Code	612, 625, 626	605, 606, 613	630
CRML201DLWM	408.00	416.00	426.00
CRML202DLWM	462.00	470.00	480.00
CRML2022LWM	548.00	556.00	566.00
CRML2030LWM	462.00	470.00	480.00
CRML2048LWM	515.00	523.00	533.00
CRML2050LWM	158.00	162.00	167.00
CRML2051LWM	495.00	503.00	513.00
CRML2055LWM	495.00	503.00	513.00
CRML2057LWM	495.00	503.00	513.00
CRML2067LWM	515.00	523.00	533.00
CRML2070LWM	316.00	324.00	334.00

CSA

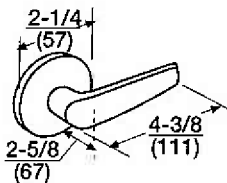

Lever: Cast
Rose: Wrought

Code	612, 625, 626	605, 606, 613	630
CRML2010CSA	494.00	502.00	512.00
CRML2020CSA	550.00	558.00	568.00
CRML2022CSA	636.00	644.00	654.00
CRML2030CSA	550.00	558.00	568.00
CRML2048CSA	603.00	611.00	621.00
CRML2050CSA	202.00	206.00	211.00
CRML2051CSA	583.00	591.00	601.00
CRML2055CSA	583.00	591.00	601.00
CRML2057CSA	583.00	591.00	601.00
CRML2067CSA	603.00	611.00	621.00
CRML2070CSA	404.00	412.00	422.00

PSA

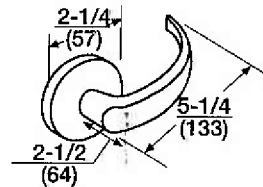

Lever: Cast
Rose: Wrought

Code	612, 625, 626	605, 606, 613	630
CRML2010PSA	494.00	502.00	512.00
CRML2020PSA	550.00	558.00	568.00
CRML2022PSA	636.00	644.00	654.00
CRML2030PSA	550.00	558.00	568.00
CRML2048PSA	603.00	611.00	621.00
CRML2050PSA	202.00	206.00	211.00
CRML2051PSA	583.00	591.00	601.00
CRML2055PSA	583.00	591.00	601.00
CRML2057PSA	583.00	591.00	601.00
CRML2067PSA	603.00	611.00	621.00
CRML2070PSA	404.00	412.00	422.00

DSA

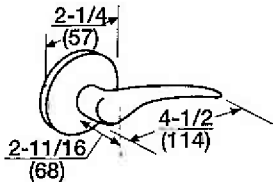

Lever: Cast
 Rose: Wrought

Code	612, 625, 626	605, 606, 613	630
CRML2010DSA	488.00	496.00	506.00
CRML2020DSA	546.00	554.00	564.00
CRML2022DSA	628.00	636.00	646.00
CRML2030DSA	546.00	554.00	564.00
CRML2048DSA	597.00	605.00	615.00
CRML2050DSA	199.00	203.00	208.00
CRML2051DSA	577.00	585.00	595.00
CRML2055DSA	577.00	585.00	595.00
CRML2057DSA	577.00	585.00	595.00
CRML2067DSA	597.00	605.00	615.00
CRML2070DSA	398.00	406.00	416.00

DSM

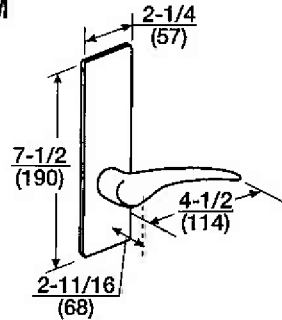

Lever: Cast
 Escutcheon: Wrought

Code	612, 625, 626	605, 606, 613	630
CRML2010DSM	496.00	504.00	514.00
CRML2020DSM	554.00	562.00	572.00
CRML2022DSM	636.00	644.00	654.00
CRML2030DSM	554.00	562.00	572.00
CRML2048DSM	605.00	613.00	623.00
CRML2050DSM	203.00	207.00	212.00
CRML2051DSM	585.00	593.00	603.00
CRML2055DSM	585.00	593.00	603.00
CRML2057DSM	585.00	593.00	603.00
CRML2067DSM	605.00	613.00	623.00
CRML2070DSM	406.00	414.00	424.00

PUSH-PULL LATCH

Handing: Non-handed

Door Thickness: 1 3/4"

Backset: 5"

Strike: 2 3/4" x 1 1/8" x 1 1/4" lip to center

Case quantity: 6

Case Weight: 35 lbs.

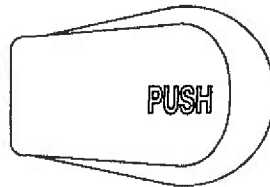

CRHL11-626 Standard Pull Lever Satin Chrome

508⁰⁰

Now Available With **MicroShield™**, Anti-Microbial Finish. Specify 626C Finish.
 Note: \$30 Upcharge per Lockset.

**WE ARE A FULL - LINE
 CORBIN/RUSSWIN
 STOCKING DISTRIBUTOR.
 OVER 3200 ITEMS
 IN STOCK**

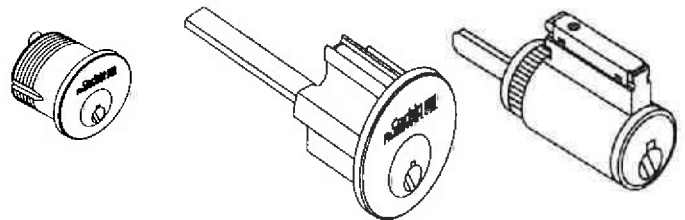

**FULL LINE OF CYLINDERS
 ALL KEYWAYS
 MORTISE - RIM - IC**

UNIT LOCKSETS

Handing: Specify LH or RH
Door Thickness: 1 3/4" only
Backset: 2 3/4" only
Strike: ANSI curved lip, 4 7/8" x 1 1/4" lip to center
Cylinder: Brass, 6-pin, L4 keyway, O-bitted
Keys: Two nickel silver keys

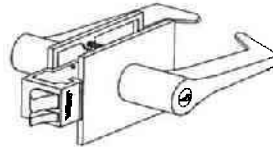

ESE

Lever: Forged
Escutcheon: Forged

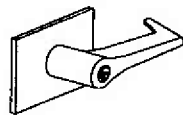

Code	612,626
PASSAGE	
CRUT5210	674.00
PRIVACY	
CRUT5220	742.00
ENTRANCE	
CRUT5251	812.00
CLASSROOM	
CRUT5255	812.00
STOREROOM	
CRUT5257	812.00

GRE

Knob: Forged
Escutcheon: Forged



9/case

Code	612,626
PASSAGE	
CRUT5210GRE	628.00
PRIVACY	
CRUT5220GRE	700.00
ENTRANCE	
CRUT5251GRE	774.00
CLASSROOM	
CRUT5255GRE	774.00
STOREROOM	
CRUT5257GRE	774.00

DC3210 DOOR CLOSER

Cast Iron Body. Comes w/ Sex nuts & bolts.

Adjustable 1-6. Meets or exceeds ANSI A156.4 Grade 1

Unique pressure-relief backcheck intensity valve includes safety feature to maintain correct internal pressure. **UBC/UL10C:** Listed for Fire and Cycle Requirements

Warranty: 5 years limited.

Finishes: 689 Painted Aluminum 690 Painted Dark Bronze 691 Painted Light Bronze



P/N	Arm	Price
CRDC3210-M54	Tri-Pack	234.00
CRDC3210-M54-A1	Tri-Pack w/Hold Open	262.00
CRDC3210-M54-A2	HD Parallel w/Hold Open	274.00
CRDC3210-M54-A3	HD Parallel	253.00
CRDC3210-M54-A4	HD Parallel w/Backstop	270.00

DC6210 DOOR CLOSER

Cast Iron Case. Comes w/ Sex nuts & bolts. Heavy Duty Forged Arm

Adjustable 1-6. Meets ANSI A156.4 Grade 1

Multiple backcheck location valve and backcheck intensity valve standard.

UL/ULC/UL10C: Listed for Fire and Cycle Requirements

Warranty: 10 years limited.

Finishes: 689 Painted Aluminum 690 Painted Dark Bronze



P/N	Arm	Price
CRDC6210-M54	Tri-Pack	275.00
CRDC6210-M54-A1	Tri-Pack w/Hold Open	303.00

DC8210 DOOR CLOSER

Cast Iron Body. Heavy Duty Forged Arm

Adjustable 1-6. Meets ANSI A156.4 Grade 1

UL10C/UBC 7-2C: Meets Positive Pressure Fire Test Requirements

Warranty: 10 years limited.

Tri-packed Assembly (regular arm, top jamb & parallel arm mounting)

Non-handed

Finishes: 689 Painted Aluminum 690 Painted Dark Bronze 691 Painted Light Bronze

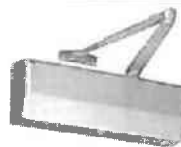

P/N	Arm	Price
CRDC8210-M54	Tri-Pack	308.00
CRDC8210-M54-A1	Tri-Pack w/Hold Open	336.00

KEYBLANKS

CRAAR-6PIN-10v CRA1-5PIN-10 CRA1-6PIN-10 CRA1x12-5PIN-10 CRA2-5PIN-10 CRA2-6PIN-10 CRA3-5PIN-10 CRA3-6PIN-10 CRA4-5PIN-10 CRA4-6PIN-10 CRA5-5PIN-10 CRA5-6PIN-10 CRA6-5PIN-10 CRA6-6PIN-10 CRA7-5PIN-10 CRA7-6PIN-10 CRA8-5PIN-10 CRA8-6PIN-10 CRA9-5PIN-10 CRA9-6PIN-10 CRA10-5PIN-10 CRA10-6PIN-10 CRA11-5PIN-10 CRA12-5PIN-10 CRA12-6PIN-10 CRA13-5PIN-10 CRA14-5PIN-10 CRA15-5PIN-10 CRA15-6PIN-10 CRA16-5PIN-10 CRA16-6PIN-10 CRA17-5PIN-10 CRA18-5PIN-10 CRA18-6PIN-10 CRA19-5PIN-10 CRA19-6PIN-10 CRA20-5PIN-10 CRA20-6PIN-10 CRA21-5PIN-10 CRA21-6PIN-10 CRA22-5PIN-10 CRA22-6PIN-10 CRA23-5PIN-10 CRA23-6PIN-10 CRA24-5PIN-10 CRA24-6PIN-10 CRBL-5PIN-10 CRBL-6PIN-10 CRBR-5PIN-10 CRBR-6PIN-10 CRD1-5PIN-10 CRD1-6PIN-10 CRD1-6PIN-10B CRD1-6PIN-90 CRD1-7PIN-10 CRD12-5PIN-10 CRD12-6PIN-10 CRD12-7PIN-10	CRD2-5PIN-10 CRD2-6PIN-10 CRD2-6PIN-10B CRD2-7PIN-10 CRD3-5PIN-10 CRD3-6PIN-10 CRD3-6PIN-10B CRD3-7PIN-10 CRD34-5PIN-10 CRD34-6PIN-10 CRD4-5PIN-10 CRD4-6PIN-10 CRD4-6PIN-10B CRD4-7PIN-10 CRD41-5PIN-10 CRD41-7PIN-10 CRG-5PIN-10 CRG310-626 CRG355-612 CRG355-626 CRH1-5PIN-10 CRH1-6PIN-10 CRH1-6PIN-10B CRH1-6PIN-II CRH1-7PIN-10 CRH12-5PIN-10 CRH12-6PIN-10 CRH2-5PIN-10 CRH2-6PIN-10 CRH2-6PIN-10B CRH2-7PIN-10 CRH3-5PIN-10 CRH3-6PIN-10 CRH3-6PIN-10B CRH3-7PIN-10 CRH34-5PIN-10 CRH34-6PIN-10 CRH4-5PIN-10 CRH4-6PIN-10 CRH4-6PIN-10B CRH4-7PIN-10 CRH41-5PIN-10 CRH41-6PIN-10 CRH5-5PIN-10 CRH5-6PIN-10 CRH5-6PIN-10B CRH5-7PIN-10 CRH56-6PIN-10 CRH6-5PIN-10 CRH6-6PIN-10B CRH6-7PIN-10 CRH7-5PIN-10 CRH7-6PIN-10 CRH7-6PIN-10B CRH78-5PIN-10 CRH78-6PIN-10 CRH8-5PIN-10 CRH8-6PIN-10 CRH8-6PIN-10B CRH81-5PIN-10 CRH81-6PIN-10	CRH85-5PIN-10 CRH85-6PIN-10 CRL1-5PIN-10 CRL1-6PIN-10 CRL1-6PIN-10B CRL1-7PIN-10 CRL12-5PIN-10 CRL12-6PIN-10 CRL2-5PIN-10 CRL2-6PIN-10 CRL2-6PIN-10B CRL2-7PIN-10 CRL3-5PIN-10 CRL3-6PIN-10 CRL3-6PIN-10B CRL3-7PIN-10 CRL34-5PIN-10 CRL34-6PIN-10 CRL4-5PIN-10 CRL4-5PIN-10B CRL4-6PIN-10 CRL4-6PIN-10B CRL4-7PIN-10 CRL41-5PIN-10 CRL41-6PIN-10 CRL41-7PIN-10 CRNI-12M-7PIN-10 CRNI-3-9-12M CRNI-5PIN-10 CRNI-6PIN-10B CRNI-7PIN-10 CRNIX13M-6PIN-10 CRN10-5PIN-10 CRN10-6PIN-10 CRN10-6PIN-10B CRN10-7PIN-10 CRN11-5PIN-10 CRN11-6PIN-10 CRN11-6PIN-10B CRN12-5PIN-10 CRN12-6PIN-10 CRN12-6PIN-10B CRN12-7PIN-10 CRN13-5PIN-10 CRN13-6PIN-10B CRN14-5PIN-10 CRN14-6PIN-10 CRN15-17-23-26M CRN15-27M CRN15-5PIN-10 CRN15-6PIN-10 CRN15X27M-6PIN-10 CRN16-22M CRN16-6PIN-10 CRN17-5PIN-10 CRN17-6PIN-10 CRN18-6PIN-10 CRN18-6PIN-10B CRN18-7PIN-10	CRN19-5PIN-10 CRN19-6PIN-10 CRN2-5PIN-10 CRN2-6PIN-10 CRN2-6PIN-10B CRN2-7-8-10M-6PIN-10 CRN2-8M CRN20-5PIN-10 CRN20-6PIN-10 CRN21-24M CRN21-24M-6PIN-10 CRN21-5PIN-10 CRN21-6PIN-10 CRN22-5PIN-10 CRN22-6PIN-10 CRN23-5PIN-10 CRN23-6PIN-10 CRN23-7PIN-10 CRN24-6PIN-10 CRN24-6PIN-10 CRN25-5PIN-10 CRN25-6PIN-10 CRN26-5PIN-10 CRN26-6PIN-10 CRN27-5PIN-10 CRN27-6PIN-10 CRN27-6PIN-10B CRN27-7PIN-10 CRN28-5PIN-10 CRN28-6PIN-10 CRN3-9-5PIN-10 CRN3-5PIN-10 CRN3-6PIN-10 CRN3-6PIN-10B CRN3-9M-6PIN-10 CRN4-5PIN-10 CRN4-6PIN-10 CRN4-6PIN-10B CRN5-5PIN-10 CRN5-6PIN-10 CRN5-6PIN-10B CRN5-7PIN-10 CRN555-626 CRN557-626 CRN557-626-LC CRN6-5PIN-10 CRN6-6PIN-10 CRN6-6PIN-10B CRN6-7PIN-10 CRN7-10M CRN7-5PIN-10 CRN7-6PIN-10 CRN7-6PIN-10B CRN7-7PIN-10 CRN8-5PIN-10 CRN8-6PIN-10 CRN8-6PIN-10B CRN8-7PIN-10 CRN9-5PIN-10 CRN9-6PIN-10 CRN9-6PIN-10B	CRN9-7PIN-10 CRZ1-59A1-5 CRZ1-59A1-6 CRZ1-59A2-6 CRZ1-59B1-6 CRZ1-60-6 CRZ1-60-7 CR252-5PIN-10 CR252-6PIN-10 CR27-5PIN-10 CR27-5PIN-10B CR27-6PIN-10 CR27-6PIN-10B CR27A-5PIN-10 CR27A-6PIN-10 CR27AB-5PIN-10 CR27AB-6PIN-10 CR27A1-5PIN-10 CR27A1-6PIN-10 CR27A1-6PIN-10B CR27A2-5PIN-10 CR27A2-6PIN-10 CR27A2-6PIN-10B CR27B-5PIN-10 CR27B-6PIN-10 CR27B1-5PIN-10 CR27B1-6PIN-10 CR27B1-6PIN-10B CR27B2-5PIN-10 CR27B2-6PIN-10 CR27B2-6PIN-10B CR28-5PIN-10 CR28-6PIN-10 CR2852-5PIN-10 CR29-5PIN-10 CR29-6PIN-10 CR57A-5PIN-10 CR57A-6PIN-10 CR57ABC-5PIN-10 CR57ABC-7PIN-10 CR57AD-5PIN-10 CR57AD-6PIN-10 CR57A1-5PIN-10 CR57A1-6PIN-10 CR57A1-6PIN-10B CR57A2-5PIN-10 CR57A2-6PIN-10 CR57A2-6PIN-10B CR57B-6PIN-10 CR57B1-5PIN-10 CR57B1-6PIN-10B CR57B2-5PIN-10 CR57B2-6PIN-10 CR57B2-6PIN-10B CR57C-6PIN-10 CR57C1-5PIN-10 CR57C1-6PIN-10 CR57C1-6PIN-10B CR57C2-5PIN-10	CR57C2-6PIN-10 CR57C2-6PIN-10B CR57D-6PIN-10 CR57D1-5PIN-10 CR57D1-6PIN-10 CR57D1-6PIN-10B CR57D1-7PIN-10 CR57D2-5PIN-10 CR57D2-6PIN-10B CR57D2-7PIN-10 CR57D2-7PIN-10 CR59A-5PIN-10 CR59A-6PIN-10 CR59AB-5PIN-10 CR59AB-6PIN-10 CR59AD-5PIN-10 CR59AD-6PIN-10 CR59AD-7PIN-10 CR59A1-6PIN-10 CR59A1-6PIN-10B CR59A1-7PIN-10 CR59A1-7PIN-90 CR59A2-5PIN-10 CR59A2-6PIN-10 CR59A2-6PIN-10B CR59B-5PIN-10 CR59B-6PIN-10 CR59B1-5PIN-10 CR59B1-6PIN-10 CR59B1-7PIN-10 CR59B2-5PIN-10 CR59B2-6PIN-10 CR59B2-6PIN-10B CR59C-5PIN-10 CR59C-6PIN-10 CR59C-7PIN-10 CR59CD-5PIN-10 CR59CD-6PIN-10 CR59CI-5PIN-10 CR59CI-6PIN-10 CR59CI-6PIN-10B CR59CI-7PIN-10 CR59C2-5PIN-10 CR59C2-6PIN-10 CR59C2-6PIN-10B CR59D-6PIN-10 CR59D-7PIN-10 CR59DI-5PIN-10 CR59DI-6PIN-10 CR59DI-6PIN-10B CR59D1-7PIN-10 CR59D2-5PIN-10 CR59D2-6PIN-10 CR59D2-6PIN-10B CR60-5PIN-10 CR60-5PIN-10B	CR60-6PIN-10 CR60-6PIN-10B CR60-6PIN-90 CR60-7PIN-10 CR60-7PIN-10 CR67-5PIN-10 CR67-5PIN-10B CR67-5PIN-10B CR67-6PIN-10 CR67-6PIN-10B CR67-7PIN-10 CR67A-5PIN-10 CR67A-6PIN-10 CR67AB-5PIN-10 CR67AB-6PIN-10 CR67A1-5PIN-10 CR67A1-6PIN-10 CR67A1-6PIN-10B CR67A2-5PIN-10 CR67A2-6PIN-10 CR67A2-6PIN-10B CR67A2-7PIN-10 CR67B-5PIN-10 CR67B1-6PIN-10 CR67B1-6PIN-10B CR67B2-5PIN-10 CR67B2-6PIN-10 CR67B2-6PIN-10B CR68-5PIN-10 CR68-6PIN-10 CR69-5PIN-10 CR70-5PIN-10 CR752-5PIN-10 CR77-5PIN-10 CR77-5PIN-10B CR77-6PIN-10 CR77-6PIN-10B CR77-7PIN-10 CR77A-6PIN-10 CR77AB-5PIN-10 CR77A1-5PIN-10 CR77A1-6PIN-10 CR77A1-6PIN-10B CR77A2-5PIN-10 CR77A2-6PIN-10 CR77A2-6PIN-10B CR77B-6PIN-10 CR77A2-7PIN-10 CR77B-6PIN-10B CR77B1-5PIN-10 CR77B1-6PIN-10 CR77B1-6PIN-10B CR77B2-5PIN-10 CR77B2-6PIN-10 CR77B2-6PIN-10B CR77B2-7PIN-10 CR78-5PIN-10	CR79-5PIN-10 CR852-5PIN-10 CR852-5PIN-10B CR852-6PIN-10 CR97-5PIN-10 CR97-5PIN-10B CR97-6PIN-10 CR97-7PIN-10 CR981-5PIN-10 CR981-5PIN-10B CR981-6PIN-10 CR981-6PIN-10B CR9812-5PIN-10 CR982-5PIN-10 CR982-6PIN-10 CR982-6PIN-10B CR983-7PIN-10 CR983-5PIN-10 CR983-6PIN-10 CR983-6PIN-10B CR983-7PIN-10 CR99-5PIN-10B CR99-6PIN-10	WE CARRY A COMPLETE ASSORTMENT OF KEYBLANKS AND CYLINDERS, IN MANY DIFFERENT KEYWAYS. PLEASE CALL FOR ALL YOUR REQUIRE- MENTS.	
---	---	---	---	---	---	--	--	---	--

•DEADLOCKS

•DOOR CLOSERS
•EXIT DEVICES

DEADLOCKS

Grade II Ansi 156.5

Backset: 2 3/4"
Door Thickness: 1 3/8" - 2 1/4"
Strike: 2 3/4" x 1 1/8"
Cylinder: Brass, 6 pin



Bright Brass or Satin Chromium

P/N	Function	Price
CRDL2113	Single Cylinder	115.00
CRDL2112	Double Cylinder	162.00
CRDL2117	Classroom	115.00

DEADLOCKS

Grade I Ansi 156.5

Backset: 2 3/4"
Door Thickness: 1 3/8" - 2 1/4"
Strike: 2 3/4" x 1 1/8"
Cylinder: Brass, 6 pin



Bright Brass, Satin Bronze or Satin Chromium

P/N	Function	Price
CRDL3113	Single Cylinder	139.00
CRDL3112	Double Cylinder	186.00
CRDL3117	Classroom	139.00

MORTISE DEADLOCKS

Door Thickness: 1 3/4"
Backset: 2 3/4"
Strike: 3 1/2" x 1 1/8"
Cylinder: 6 pin
Bright Brass, Satin Bronze or Satin Chromium



P/N	Function	612-626	605
CRDL4013	Single Cylinder	187.00	189.00
CRDL4012	Double Cylinder	240.00	242.00
CRDL4017	Classroom	199.00	201.00

RIM TYPE PUSHBAR EXIT DEVICES

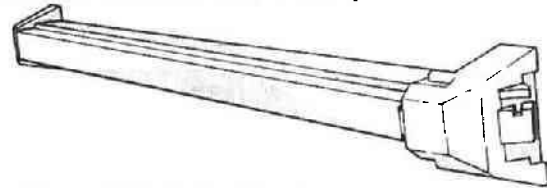

Code	Size	Finish	Price
CRED8200-30-691	30"	Dull Bronze Lacquer	327.00
CRED8200-30-690	30"	Bronze Enamel	327.00
CRED8200-30-689	30"	Silver Aluminum Lacquer	327.00
CRED8200-36-691	36"	Dull Bronze Lacquer	327.00
CRED8200-36-690	36"	Bronze Enamel	327.00
CRED8200-36-689	36"	Silver Aluminum Lacquer	327.00
CRED8200-42-691	42"	Dull Bronze Lacquer	327.00
CRED8200-42-689	42"	Silver Aluminum Lacquer	327.00
CRED8200-48-691	48"	Dull Bronze Lacquer	356.00
CRED8200-48-689	48"	Silver Aluminum Lacquer	356.00

VERTICAL ROD TYPE EXIT DEVICES

36" **565.00**ea.
48" **594.00**ea.

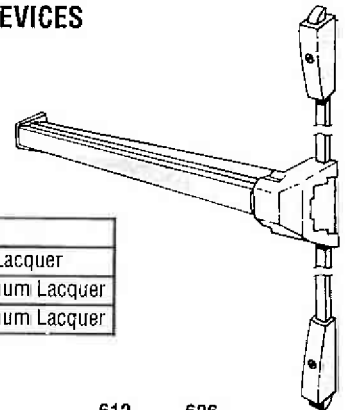

Specify LH or RH

Code	Finish
CRED8400-36-691	Dull Bronze Lacquer
CRED8400-36-689	Silver Aluminum Lacquer
CRED8400-48-689	Silver Aluminum Lacquer

KNOB TRIM



G1055 Classroom	612	626
	187.00	181.00
G1010 Passage	173.00	167.00

PULL TRIM/LEVER TRIM

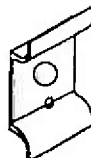

P857	P850	691 Dull Bronze Lacquer
Outside by Pull	Dummy, no	689 Silver Aluminum Lacquer
except when	cylinder hole	690 Bronze Enamel
locked by key	57.00	
57.00		



N610	612, 626
Passage	203.00
N655	
Classroom	215.00
N657	
Nightlatch	215.00
N659	
Storeroom	215.00