



THE "SPIN OUT" SCREWDRIVER for MORTISE CYLINDERS

Designed to remove the cam screws on mortise cylinders, even the most stubborn. The "Spin Out" features a screwdriver with an oversized handle for extra torque. Four sizes of interchangeable screwdriver bits - two slotted and two Phillips.

Includes a stand, with bronze bearing, to prevent the screwdriver from slipping. Allows you to provide constant, even pressure to the screws.

- Prevents Injuries to You and Your Employees' hands, caused by a screwdriver slipping
- Prevents stripped out screw heads
- Allows you to remove even the most stubborn screws

KMSPIN
93⁹⁰

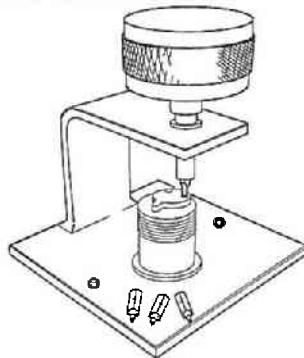

CYLINDER GUARD RING

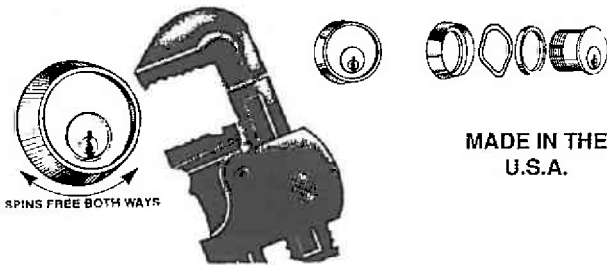

MADE IN THE U.S.A.

Hardened Steel - Free Spinning - Tapered - Cone Shaped
 Large enough to even accommodate 1 1/8" cylinders

KMK-24A	6 pack (incl. stainless steel wave washers, spacers)	Aluminum	28.25
KMK-24B	6 pack (incl. stainless steel wave washers, spacers)	Duranodic	28.25
KMK-24-3	Individual pack	Bright Brass	9.98
KMK-24-4	Individual pack	Satin Brass	9.98
KMK-24-10	Individual pack	Satin Bronze	9.98
KMK-24-19	Individual pack	Black	5.17
KMK-24-26	Individual pack	Bright Chrome	9.98
KMK-24-26D	Individual pack	Satin Chrome	9.98

ROLL PIN KIT

Contains an assortment of the zinc plated roll pins most commonly used by locksmiths. Includes sizes 1/16" thru 5/32" diameter and 3/8" thru 1 1/2" length. 18 different sizes. 480 total pins. Durable, 18 compartment box.

KMK-RP
47⁰⁵

KMK-RP-M
 Metric
52⁸¹

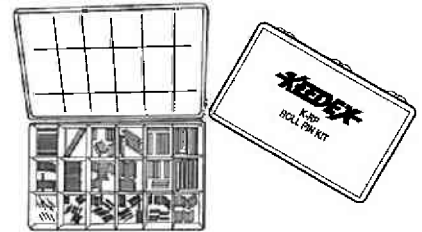

MASTER FOLLOWER

Great for both novice and master locksmith, this reasonably priced machined follower far exceeds the capabilities of any other follower on the market today. Can be used as a regular follower or master pin remover and follower on Schlage, Sargent, Kwikset, Weiser, and Alimont padlocks. Special taper enables smooth operation and a higher degree of control over sticking pins. Made of Solid Brass .495" dia. x 4" 1/4" (L).

KMK-6
26⁹⁸

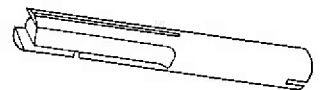

MASTER FOLLOWER FOR CORBIN/RUSSWIN

Can be used with both .500" & .550" plugs. Made of solid brass.

KMK-6-COR
38³³



Picture showing K-6 COR with sleeve on, for use with .550" plugs and with sleeve removed, for use with .500" plugs

K-TMPA/R INSTALLATION

TEMPLATE FOR ADAMS RITE

Allows you to make precise installation of Adams Rite 1850S, 4530, 4710 & 4711 series locks. Also works with International DH1822 & DL4511. Covers the following backsets: 7/8", 31/32", & 1 1/8".

Includes guide for Adams Rite exit indicator #4089.

Has cutout for BBW #3925 & International FB-1200 flush bolts.

Designed to be used with a 1/2" router guide with a 1/4" bit.

KMK-TMPA/R
98⁴⁷

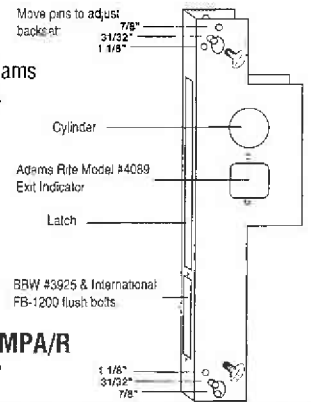

SCOPE

An invaluable tool for locksmiths and safemen! Converts mini-flashlights, such as Mini-Mag Lite and Brinkman, into high intensity inspection lights. Consists of a cap and two interchangeable fiber-optic rods, one 45° and one 90°.

KMK-23
8³²

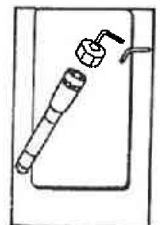



- WELDABLE GATE BOXES
- GM LOCK BLOCK
- V. A. T. S. INTERROGATOR
- MASTER FOLLOWER

SINGLE LOCK BOX

2 1/8" hole.
Box dimensions: 3 1/2" (H) x 4 1/2" (L) Black finish.

Part No.	Backset	Width	List
KMK-BXSGL	2 3/8"	1 5/8"	8.27
KMK-BXSGL-234	2 3/4"	1 5/8"	18.35
KMK-BXSGL-S	2 3/8"	1 1/4"	8.27
KMK-BXSGL-ES	2 3/8"	1"	8.27

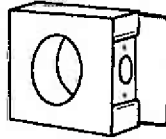

DOUBLE LOCK BOX

2 3/8" backset. 2 1/8" hole. Black finish.

Part No.	Height	Length	Width	List
KMK-BXDDBL	6 7/8"	4 1/2"	1 1/2"	10.86
KMK-BXDDBL-S	6 7/8"	4 1/2"	1 1/4"	10.86
KMK-BXDDBL-ES	7 1/2"	4 1/2"	1"	10.86
2 3/4" backset				
KMK-BXDDBL234	8 5/8"	4 3/4"	1 1/2"	45.93

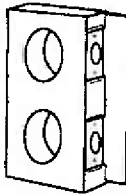

LOCK BOX FOR ADAMS RITE

For Adams Rite 1850S, 1851S, 4710 and 4711. Also fits ASSA 8508, 8508, 8513, and 8518, and 8518; and International DH1822 and DL4511. 1 1/8" backset.
Box dimensions: 7" (H) x 11 15/16" (L) x 1 3/4" (W).

KMK-BXA/R	KMK-BXA/R-AL	KMK-BXA/R-31/32
Black Finish	Aluminum	31/32" BS, Black Finish
16⁰¹	37⁹⁷	16⁰¹

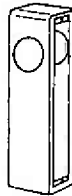

LOCK BOX FOR SIMPLEX/UNICAN 1000

A weldable gate box used for the Simplex Unican series.
Box dimensions: 9 1/4" (H) x 5 1/2" (L) x 1 7/8" (W).
Black finish.

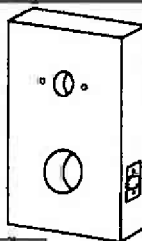

P/N	Description	Price
KMK-BXSIM	1000 Series-Alarm Lk Trilogy DL2500	58.38
KMK-BXSIM-AL	Aluminum Box for above applications	86.22
KMK-BXSIM-EE	EE1000 Series	60.05
KMK-BXSIM-EE-AL	Aluminum Box for above application	87.61
KMK-BXSIM-200	200 Series - 904, 905, 918, 919	37.78
KMK-BXSIM-200-AL	Aluminum Box for above application	62.11
KMK-BXSIM-4000	4000 Series	80.90
KMK-BXSIM-4000-AL	Aluminum Box for above application	123.77
KMK-BXSIM-6004	6000 Series 2 3/4" Backset	43.35
KMK-BXSIM-6218	6200 Series 2 3/8" Backset	43.35
KMK-BXSIM-7004	7004	43.35

BOX FOR SCHLAGE®RHODES

Weldable gate box for the Schlage®Rhodes Lockset

Box Dimensions: 4 1/8" H x 4 3/4" L x 1 5/8" W

KMK-BXRHO	39.67
KMK-BXRHO-AL Aluminum	49.75

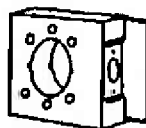

ELECTRIC STRIKE BOXES

Weldable gate box use for installing EffEff 11BS, Rofu 1106 and Trine 005 electric strikes.

Box dimensions: 3 3/4" H x 3 1/2" L x 1 9/16" W

KMK-BXES1
23³⁸

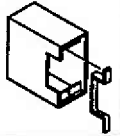

This box is used for installing the Eff Eff 3314, 4114/4314, 5114/5314 & 7114 electric strikes. Works with Adams Rite 7000, 7001, & 7040. Also the Rofu 1402, 1702 & 3402.

Box dimensions: 5 1/16" H x 2 3/8" L x 1 3/4" W

KMK-BXES2
23³⁸



Weldable gate box used for installing Adams Rite 7100, 7101, 7140 electric strikes.

Box dimensions: 6 7/16" H x 2 3/8" L x 1 3/4" W

KMK-BXES3A
25⁰³



Weldable gate box used for installing the Von Duprin 3140 & 6211 electric strikes. Also for the Folger Adam 712 & 712-75.

Box dimensions: 6 7/16" H x 2 3/8" L x 1 3/4" W

KMK-BXES4
28³¹

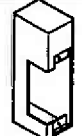

KMK-BXES5	For H.E.S. 1003	25.03
KMK-BXES6	For H.E.S. 7001	25.03
KMK-BXES7	For Folger Adam 310-2 3/4, 712, 712-75	77.00
KMK-BXES8	For Trine 001	23.38
KMK-BXES9	For H.E.S. 7501	24.64
KMK-BXMAS	For Mas-Hamilton Power Lever	60.05
KMK-BXLOC5100	For Locknetics 5100	69.99
KMK-BXIL	For Ilco 700II	76.56
KMK-BXIL-AL	Aluminum, For Ilco	100.14
KMK-BXIL-710	For Ilco 710	90.34
KMK-BXVING	For Vingcard	77.17

LOCK BOX FOR MORTISE LOCKS

KMK-BXMOR1 Weldable Gate Box-Schlage L series Sargent 7700/8100 47.77

KMK-BXMOR2 Weldable Gate Box-Corbin Russwin 5000 Series 47.77

KMK-BXMOR3 Weldable Gate Box-No Trim Hole (cylinder hole only) 46.91

KMK-BXMOR4 Weldable Gate Box-No Trim Hole No Cylinder Hole 45.93

Box Dimensions: 8 1/8" H x 4 5/8" L x 1 3/4" W

KMK-BXMOR-MR3000M Marks3000M

KMK-BXMOR-SGT4874 Sargent 4874
Box Dimensions: 4 7/8" H x 4 1/2" L x 1 3/4" W

38²⁸

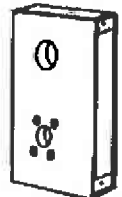



SAFE CHANGE KEY SET

Invaluable for every locksmith.

Save the time and trouble of searching for the right change key in your toolbox. The Keedex solution is a fan-fold, pocket-knife style tool containing 12 of the most common change keys. Engraved to describe appropriate use; the keys are made of solid stainless steel.

KMK-18
141⁹⁵

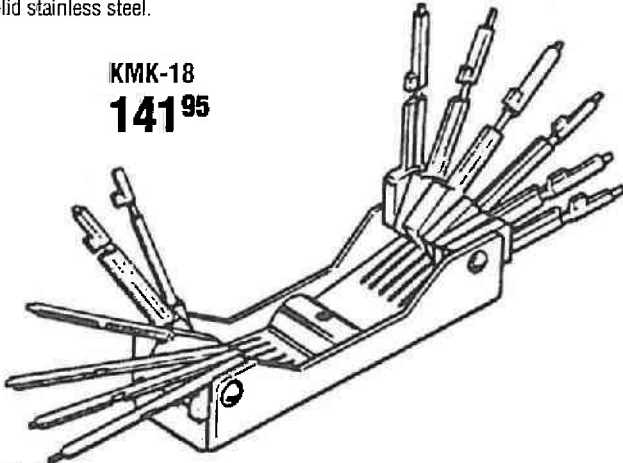

KMK-18-1	Mosler 4 Wheel
KMK-18-2	Mosler 302 3 Wheel
KMK-18-3	S & G AMSEC 3 Wheel
KMK-18-4	S & G 6720 3 Wheel
KMK-18-5	Diebold-180 3 Wheel
KMK-18-6	Diebold-177 4 Wheel

KMK-18-7	S & G Padlocks 3 Wheel
KMK-18-8	S & G 4163
KMK-18-9	LaGard R1 3 Wheel
KMK-18-10	LaGard 3 Wheel
KMK-18-11	LaGard 4 Wheel
KMK-18-12	LaGard AMSEC 3 Wheel

LEVER OPENING TOOL

Slips under door to grab lever on the inside.

KMK-22
48⁴¹

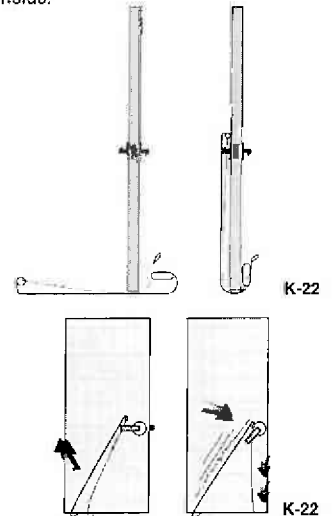

SAFE REPAIR KIT

A must for any professional locksmith who repairs safes; neat and convenient to use. An assortment of five small taper pins, milled from bar stainless steel, and corresponding ball bearings to help you repair safes with drilled holes from 1/8" to 1/2". Made in U.S.A. quality and performance that is hard to beat.

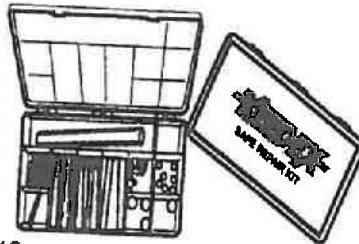

KMK-16
70⁴³

G.M. DECODER

Save yourself trouble decoding GM locks with this powerful, versatile tool. Easily and expertly decodes General Motors lock cylinders.

KMK-4
29²³

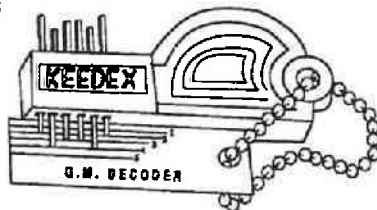

K-VATS MICRO V.A.T.S. INTERROGATOR

The new Micro V.A.T.S. lets you interrogate the system without disconnecting any wires. No special adaptors are needed.

- THE SMALLEST
- THE SIMPLEST
- THE MOST AFFORDABLY PRICED

KMK-VATS
100¹⁴

KMK-VATS-DBL
Adapter for Double Sided
VATS
33³²

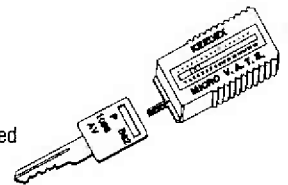

GM LOCK BLOCK

Ideally suited for working on all GM locks, and AMC and Chrysler side-bar ignitions. Uses ball bearing action to firmly hold the lock. With a vise, it can be used for staking, recoding and repairing side bar locks. The special broach cut allows you to check your work before installation in the housing.

KMK-7-10C
GM 10 Cut
33²⁴

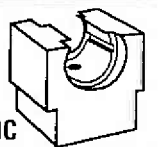

KMK-7
26¹⁷

SAFE SLICK

A special formulation lubricant gel for the professional locksmith. Use it on locking bolts, pivot points, sliding parts, panic hardware and safes.

Non-penetrating, dry, odorless, and perfectly safe to use; will not out like white grease or become gritty like black grease.

KMK-1
4⁹⁸





AskYourLocksmith.com
Lancaster, Pennsylvania
Phone 717-392-6333

ALUMINUM DOOR SECURITY

K-9, K-21 STYLE GUARD - CENTER HUNG

Made of 12 gauge steel. Style Guard reinforces or repairs aluminum stile doors. K-9 is designed for standard, center hung doors, with 4" jambs. K-21 is for 4 1/2" jambs. Designed with a "knock-out" to accommodate either the W & F or the Adams Rite bolt. Baked on powder coat finish.

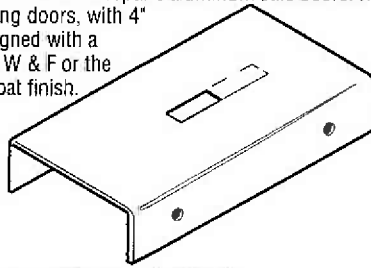

8" x 4" x 1 1/2"

P/N	Description	Price
KMK-9A	4" Aluminum finish	25.06
KMK-9B	4" Duranodic finish	25.06

8" x 4 1/2" x 1 1/4"

KMK-21A	4 1/2" Aluminum finish	25.06
KMK-21B	4 1/2" Duranodic finish	25.06

K-15 DOUBLE DOOR STYLE GUARD

Finally, a better way to secure a set of double aluminum doors. 12 gauge steel increases security and can repair doors that have already been attacked. Designed with a "knock-out" to accommodate either the W & F or the Adams Rite bolt. Baked on powder coat finish.

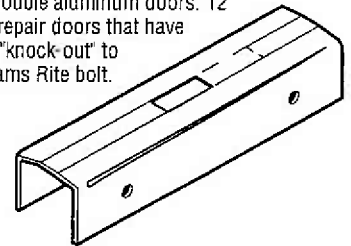

7 3/4" x 1 3/4" x 1 3/4"

P/N	Description	Price
KMK-15A	Double door aluminum finish	25.06
KMK-15B	Double door duranodic finish	25.06

K-20 OFFSET STYLE GUARD

Use the K-20 to reinforce or repair jambs with offset hung aluminum doors. This non-handed guard is easy to install and includes pop rivets and carriage bolts. Baked on powder coat finish.

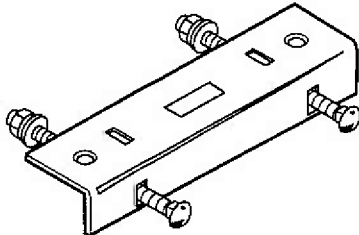

8" x 1 3/4" x 1 3/8"

P/N	Description	Price
KMK-20A	Offset style aluminum finish	23.58
KMK-20B	Offset style duranodic finish	23.58

K-17 SECURITY GUIDE & BOLT

The K-17 Security Guide & Bolt replaces the flimsy plastic guides and flush bolts provided by many manufacturers with quality steel. With a relatively simple installation, you eliminate the possibility of a burglar breaking in by merely snapping the plastic bolts.

Made of steel, cadmium plated to prevent rust, the K-17 works with the Builders Brass Works & Slide-Co. flush bolts.

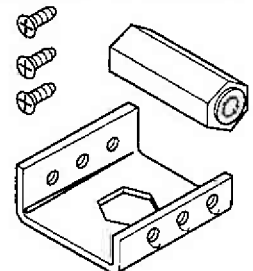

KMK-17
10¹³

SSKIT - TAMPER RESISTANT SPANNER SCREW KIT

Contains 12 each, of each of the following 14 different sizes of machine and wood/metal Tamper Resistant stainless steel screws, specifically suited to the needs of locksmiths. 168 screws total.

SSMF632X28	Spanner flat head machine screw 6-32 x 3/8"	KMSSKIT 127⁹²
SSMF632X12	Spanner flat head machine screw 6-32 x 1/2"	
SSMFU832X14	Spanner flat head undercut machine screw 8-32 x 1/4"	
SSMF832X38	Spanner flat head machine screw 8-32 x 3/8"	
SSMF832X12	Spanner flat head machine screw 8-32 x 1/2"	
SSMFU1224X12	Spanner flat head undercut machine screw 12-24 x 1/2"	
SSM01032X212	Spanner oval head machine screw 10-32 x 2 1/2"	
SSMP632X12	Spanner pan head machine screw 6-32 x 1/2"	
SSMP832X12	Spanner pan head machine screw 8-32 x 1/2"	
SSMP1032X100	Spanner pan head machine screw 10-32 x 1"	
SSSP6X34	Spanner pan head sheet metal screw #6 x 3/4"	
SSSP10X114	Spanner pan head sheet metal screw #10 x 1 1/4"	
SSSF8X34	Spanner flat head sheet metal screw #8 x 3/4"	
SSSF8X200	Spanner flat head sheet metal screw #8 x 2"	

TAMPER RESISTANT SCREWDRIVER



Invaluable For:

- ⊕ Automotive Work
- ⊕ Access Control
- ⊕ Commercial & Institutional Locksmithing

KMTAMPER
66⁷³

Keebox has a new Tamper Resistant Screwdriver. This screwdriver comes with eleven interchangeable tips. Includes the following:

- ⊕ Six tamper resistant torx tips (T10, T15, T20, T25, T27 & T30)
- ⊕ Three tamper resistant hex tips (5/32", 3/16" & 7/32")
- ⊕ Two Spanner Tips (#6 & #8)

All tips fit into the screwdriver's storage handle.



- DRILL BITS
• Safe
- PROTECT-A-LOK
• CHANGE KEY SET
- IMPRESSIONING PLATE
• COMPRESSOR

PROTECT-A-LOCK

A time and labor-saving device designed to protect knobs, levers and panic hardware, especially in heavily trafficked commercial, industrial and medical environments.

KMK-12	Cream	28.70
KMK-12D	Duranodic	28.70
KMK-12S	Stainless Steel	97.88
KMK-12S-L	Stainless Steel-Large	111.27
KMK-12S-XL24	Stainless Steel-24"	193.26
KMK-12S-XL34	Stainless Steel-34"	268.65
KMK-12S-XL41	Stainless Steel-41"	315.78

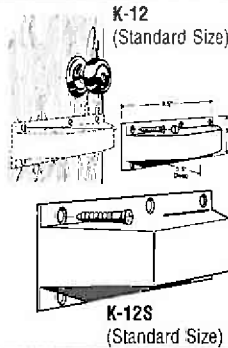

STRAIGHT SHOT

"The Ultimate Corvette Tool." Use where you have a "straight shot" at the clip. Special Feature - ball bearing holds clip in tool until YOU want it removed.



KMK-3
37⁴²

SAFE DRILL

BITS

Carbide Tip

Code	Length	Price
KMK-316x4	3/16" x 4"	7.66
KMK-316x6	3/16" x 6"	8.32
KMK-14x4	1/4" x 4"	7.66
KMK-14x6	1/4" x 6"	8.32
KMK-516x4	5/16" x 4"	9.19
KMK-516x6	5/16" x 6"	9.74
KMK-516x13	5/16" x 13"	16.68
KMK-516x30	5/16" x 30"	26.70
KMK-38x4	3/8" x 4"	10.58
KMK-38x6	3/8" x 6"	11.41
KMK-12x4	1/2" x 4"	12.58
KMK-12x6	1/2" x 6"	13.50
KMK-12x24	1/2" x 24"	28.67

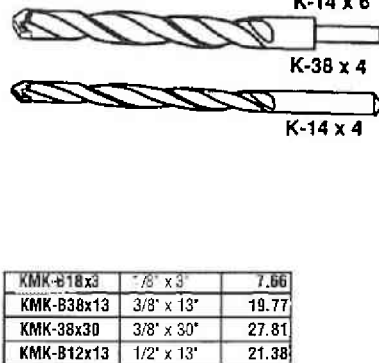

ARMORED DOOR LOOP

Use this door loop when you need to transfer electrical current from the door frame to the door.

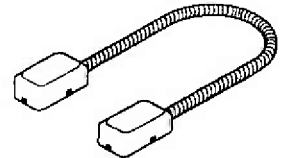

Entire assembly has an attractive and durable powder coat finish

P/N	I.D.	Length	Finish	Price
KMK-DLA	1/4"	18"	Aluminum	30.07
KMK-DLB	1/4"	18"	Duranodic	30.07
KMK-DLG	1/4"	18"	Gold	31.04
KMK-DLW	1/4"	18"	White	31.04
KMK-DLA24	1/4"	24"	Aluminum	31.65
KMK-DLB24	1/4"	24"	Duranodic	31.65
KMK-DL38A	3/8"	18"	Aluminum	38.84
KMK-DL38B	3/8"	18"	Duranodic	38.84
KMK-DL38A24	3/8"	24"	Aluminum	43.46
KMK-DL38B24	3/8"	24"	Duranodic	43.46

GSA KEY CHANGE SET

Designed for locksmiths working in the GSA environment. Contains the keys needed for servicing GSA rated containers. Key are made of cast stainless steel. Case is engraved with description of uses.

KMK-GSA
136²⁷

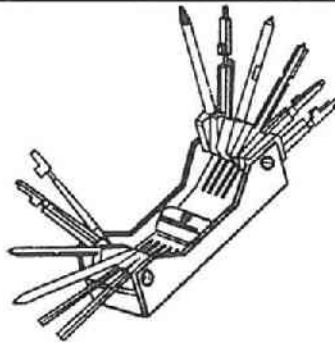

IMPRESSIONING PLATE

Specialized plate which holds locks firmly, as if they were still in the vehicle, without crushing the outside casing. Made of stainless steel.

KMK-8
Chrysler, Ford, AMC, Toyota, Nissan, camlocks
21⁶³

KMK-8B
Honda, Mazda, Nissan 82+, Toyota 83+, DD camlocks
21⁶³

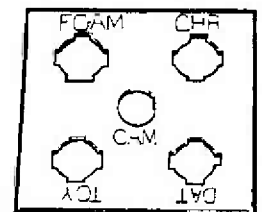

GM COMPRESSOR

A must for service trucks. Great for night calls.

Pocket-sized tool which compresses the lock plate spring on AMC, Chrysler tilt, and GM tilt, telescopic, metric and standard steering columns. Designed to use the same Phillips screwdriver required to dismantle the column.

KMK-10
16⁷⁰

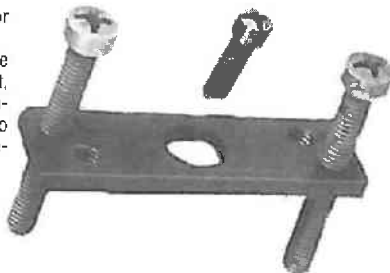

JAWS II-L CLIP REMOVAL TOOL

Designed to bump up against the lock to help remove difficult-to-jar clips. Special ball bearing holds the clip until you want it removed.

KMK-2
21²¹

