

•BEVEL PLATES

•MORTISE LOCK TRIMS

ESCUTCHEONS - SOLID BRASS

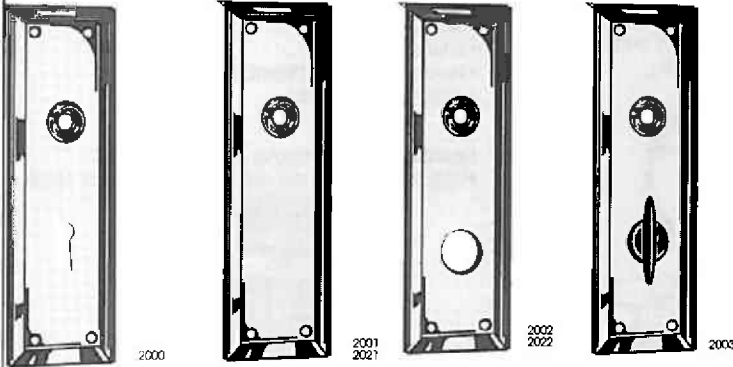

BROAD BEVEL PLATE

Solid Brass Traditional • 7" x 2 1/4"

KNOB BEARING AND KEY SLOT 12/box
PG2000-3

10⁵⁶

KNOB BEARING ONLY 12/box
PG2001-3

9³³

KNOB BEARING AND CYLINDER HOLE 12/box
Std. distance between holes is 3 11/16"

PG2002-3

10⁵⁶

KNOB BEARING AND TURN PIECE 6/box
Std. distance between hole is 2 7/16"

PG2003-3

12⁷⁶

BROAD BEVEL PLATE

Solid Brass Traditional • 10" x 2 3/4"

KNOB BEARING only 12/box
PG2021-3

13⁰³

KNOB BEARING AND CYLINDER HOLE 12/box
Std. distance between holes is 3 11/16"

PG2022-3

12³⁵

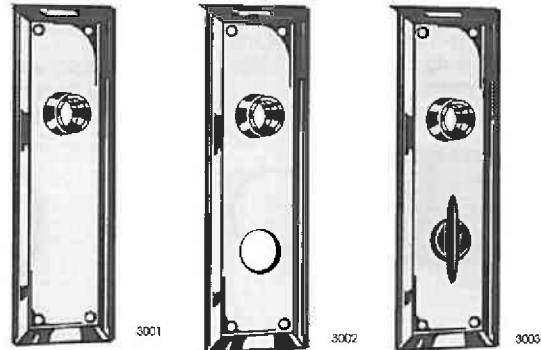

CORBIN RUSSWIN

Solid Brass Broad Bevel Plate • 9" x 2-1/2"

KNOB BEARING ONLY 6/box

PG3001-3

21⁹⁵

PG3001-10

30¹⁸

KNOB BEARING AND CYLINDER HOLE 6/box

PG3002-3

21⁹⁵

PG3002-10

30¹⁸

PG3001-26D

30¹⁸

PG3002-26D

30¹⁸

Thumbturns are not solid brass.

KNOB BEARING AND TURN PIECE 6/box

PG3003-3

19⁷⁵

PG3003-10

25³⁸

PG3003-26D

25³⁸

MORTISE ENTRANCE LOCKSET

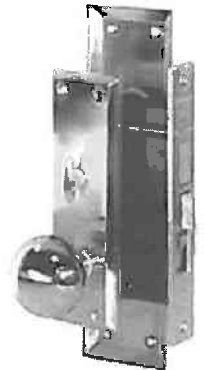

- Surface mounted escutcheon plates-Steel reinforced
- Screw on 2 1/4" Heavy Duty Brass Knobs PG63A-26D
- Two piece 9/32" steel swivel spindle
- Interior trim assembly: 7" x 2 1/4"
- Exterior trim assembly: 10" x 2 3/4"
- Backset: 2 1/2"
- Front: Solid Brass 1 1/16" x 75/8"
- Strike: 4 7/8" x 1 1/4"
- Cylinder: Brass, SE1 keyway w/2 keys
- Polished Brass US3 or Satin Chrome US26D
- Packed 10 per carton - Half LH, Half RH unless requested otherwise

60⁰⁵

PG63A-3

53⁶⁶

MARLBOROUGH PLATE Solid Brass 7-1/2" x 2-1/4"



A heavy duty rolled edge escutcheon, an attractive alternative to the traditional plate. The Marlborough plate has a large knob ferral for heavy duty knobs such as the #3600 knob.

P/N	Description	Finish	Price
PG4001-3	Knob Bearing Only	Polished Brass	21.95
PG4001-10	Knob Bearing Only	Satin Bronze	30.18
PG4001-26D	Knob Bearing Only	Satin Chrome	30.18
PG4002-3	Knob Bearing & Cylinder Hole	Polished Brass	21.95
PG4002-10	Knob Bearing & Cylinder Hole	Satin Bronze	30.18
PG4002-26D	Knob Bearing & Cylinder Hole	Satin Chrome	30.18
PG4003-3	Knob Bearing & Turn Piece	Polished Brass	24.69
PG4003-10	Knob Bearing & Turn Piece	Satin Bronze	32.92
PG4003-26D	Knob Bearing & Turn Piece	Satin Chrome	32.92

MARKS HARDWARE MORTISE LOCK TRIM

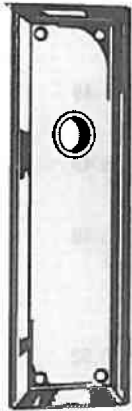

M2001
M2021

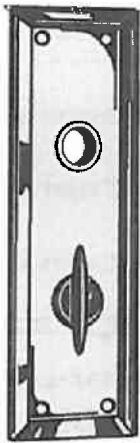

M2003

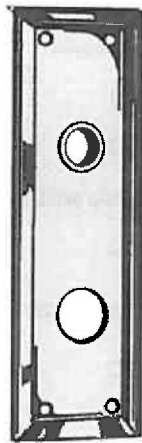

M2022

KNOB BEARING ONLY 10" x 2-3/4"
 Replaces Marks P/N A9280
 Packed 12pcs/box

PGM2021-3 Polished Brass 13.03

KNOB BEARING & CYLINDER HOLE 10" x 2-3/4"
 Replaces Marks P/N A9281
 Packed 12pcs/box

PGM2022-26D Satin Chrome 21.26
 PGM2022-3 Polished Brass 12.35

KNOB BEARING ONLY 7" x 2-1/4"
 Replaces Marks P/N A9261
 Packed 12pcs/box

PGM2001-26D Satin Chrome 17.15
 PGM2001-3 Polished Brass 9.33

KNOB BEARING & TURN PIECE 7" x 2-1/4"
 Replaces Marks P/N A9262
 Packed 6pcs/box

PGM2003-26D Satin Chrome 21.26
 PGM2003-3 Polished Brass 12.76

STEP DOWN DOOR HOLDER

5 1/8" pressure zamac casting. Poly bagged with screws.
 Packed 10 pcs./box.



PG4482BP Brass Plate 7.54
 PG4482-26D Satin Chrome 7.54

REPLACEMENT DOOR KNOBS

Solid brass, 2-1/4" replacement knob set.
 Double set screws and supplied with 3-1/2" straight spindle. Packed one pair in a display box. Standard thread is 20 TPI.

PG2600-26 Polished Chrome 31.55
 PG2600-26D Satin Chrome 26.75
 PG2600-3 Polished Brass 14.49

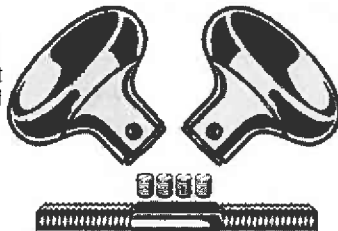

Solid brass pinned knob set, Lockwood

Outside standard duty knob prepinned to swivel spindle for 1-3/4" door with two 3/8" solid centers (3/8" x 3/8"). Inside knob threaded 18 TPI with double set screws. Packed one pair per box.

PG2600LP-10 Satin Bronze 31.55

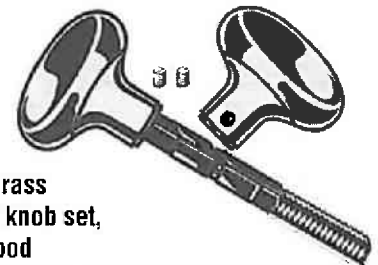

REPLACEMENT DOOR KNOB ROSES - SOLID BRASS

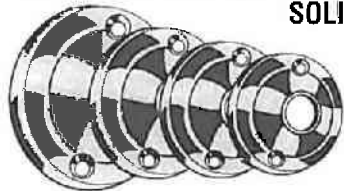

Packaged one pair per poly bag with header for hanging.

P/N	Diameter	Finish	Price
PG205-3	2"	Polished Brass	5.49
PG206-26D	2-1/4"	Satin Chrome	8.92
PG206-3	2-1/4"	Polished Brass	5.49
PG207-3	2-1/2"	Polished Brass	6.86
PG208-26D	3"	Satin Chrome	11.25
PG208-3	3"	Polished Brass	7.27

HERCULITE LOCK



Square Bolt

PG4255SQ
9877



Round Bolt

PG4255RD
9877

- Equal to Russwin S4255
- All bronze construction
- Square or round bolt
- Supplied with two mounting brackets

THRU-BOLTED KNOB/ROSE ASSEMBLY



With spring loaded spindle. Replaces Marks Hardware P/N K9220. Solid brass, M2600, 2 1/4" knobs, preassembled to roses.

PGK6220-3 Brass 21.94
 PGK6220-26D Satin Chrome 27.43

REPLACEMENT STEEL SPINDLES 20TPI

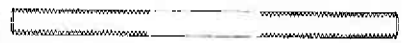

- PG44-20-3 1/2** 1.37
3 1/2" long, 9/32" square
- PG44-20-4** 1.51
4" long, 9/32" square
- PG44-20-5** 1.78
5" long, 9/32" square
- PG44-20-6** 3.43
6" long, 9/32" square



- PG45-20-R** 2.88
4 3/4" long, 9/32" square. Two 3/8" removable centers.



- PG45-20-S** 8.23
4 3/4" long, 9/32" square. Two 3/8" solid centers.

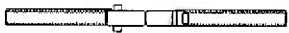

- PG45-20-P** 2.47
4 3/4" long, 9/32" square. With stop pin.

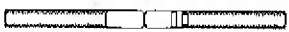

- PG45-20** 5.49
4 3/4" long, 9/32" square.



- PG45-20-SPH** 8.23
4 3/4" long, 9/32" square. Two 3/8" solid centers. Three pin holes one side.



- PG45-20-1/2SPH** 8.92
4 3/4" long, 9/32" square. One 3/8" solid center. Three pin holes one side.

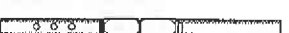

- PG45-20-RPH** 6.86
4 3/4" long, 9/32" square. Two 3/8" removable centers. Three pin holes one side



- PG45-20-C** 7.54
4 3/4" long, 9/32" square. One 3/8" solid center.

REPLACEMENT STEEL SPINDLES RUSSWIN/CORBIN - 20TPI

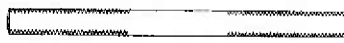

- PG44-20-4** 1.51
4" long, 9/32" square. Corbin #20

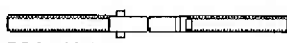

- PG45-20-P** 2.47
4 3/4" long, 9/32" square. With stop pin. Corbin #21



- PG45-20-C** 7.54
4 3/4" long, 9/32" square. One 3/8" solid center. Corbin #22



- PG45-20-32** 8.92
4 3/4" long, 9/32" square. 3/8" solid center one side, 6 pin holes one side. Corbin #32



- PG44-20-4PH** 5.49
4 3/4" long, 9/32" square. 3 pin holes one side. Corbin #30

REPLACEMENT STEEL SPINDLES LOCKWOOD - 18TPI



- PG44-18-4** 5.49
4" long, 9/32" square

- PG44-18-4 1/2** 5.49
4 1/2" long, 9/32" square. Lockwood #276A

- PG44-18-5** 5.49
5" long, 9/32" square



- PG45-18-S** 8.92
4 3/4" long, 9/32" square. Two 3/8" solid centers. Lockwood #293



- PG45-18-SPH** 8.92
4 3/4" long, 9/32" square. Two 3/8" solid centers, 3 pin holes one side.



- PG45-18-R** 8.92
4 3/4" long, 9/32" square. Two 3/8" removable centers.

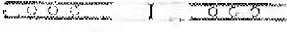

- PG45-18-NTP** 8.92
4 3/4" long, 9/32" square. With stop notch. With tapped holes: 10-24.

REPLACEMENT STEEL SPINDLES SARGENT - 16TPI



- PG44-16-4** 5.49
4" long, 9/32" square. Sargent #1632-4

- PG44-16-5** 5.49
5" long, 9/32" square. Sargent #1632-5

- PG44-16-6** 5.49
6" long, 9/32" square. Sargent #1632-6

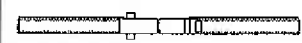

- PG45-16-P** 8.92
4 3/4" long, 9/32" square. With stop pin.



- PG45-16-S** 8.92
4 3/4" long, 9/32" square. Two 3/8" solid centers. Sargent #1635.

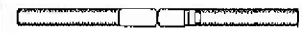

- PG45-16** 6.17
4 3/4" long, 9/32" square.

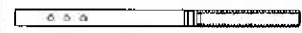

- PG45-16-PH** 8.92
4 3/4" long, 9/32" square. 3 pin holes one side.



- PG45-16-SPH** 8.92
4 3/4" long, 9/32" square. Two 3/8" solid centers. 3 pin holes one side.

SECTIONAL SPINDLES

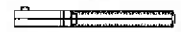

- PG46-20-2 5/8** 3.57
2 5/8" long, 9/32" square. 20 TPI. Two piece sectional spindle.

- PG46-20-3 1/2** 8.23
3 1/2" long, 9/32" square. 20 TPI. Two piece sectional spindle.

- PG46-16-2 5/8** 8.23
2 5/8" long, 9/32" square. 16 TPI. Two piece sectional spindle. For Sargent.

HEAVY DUTY SPINDLES
3/8" SQUARE x 5" LONG



PG44HD 6.17
Unthreaded straight spindle, 3/8" square x 5" long.



PG44HD-TP 8.92
Unthreaded straight spindle, 3/8" square x 5" long. With 10-24 tapped holes.



PG44HD-20 8.92
20 TPI straight spindle, 3/8" square x 5" long.



PG44HD-20-TP 12.48
20 TPI straight spindle, 3/8" square x 5" long. With 10-24 tapped holes.



PG45HD 8.92
Unthreaded swivel spindle, 3/8" square x 5" long.



PG45HD-TP 10.97
Unthreaded swivel spindle, 3/8" square x 5" long. With 10-24 tapped holes.



PG45HD-20 11.66
20 TPI swivel spindle, 3/8" square x 5" long.



PG45HD-20-TP 15.09
20 TPI swivel spindle, 3/8" square x 5" long. With 10-24 tapped holes.

PG2638-3 32.92
Solid brass, 2-1/4" knob set is tapped 1/2-20 TPI for use with the as. Knobs have a solid brass gth.



PG45HD-16 11.66
16 TPI swivel spindle, 3/8" square x 5" long. For Sargent.



SPINDLE ASSORTMENT KITS

THE MOST POPULAR SPINDLES ARE NOW AVAILABLE IN A STURDY RE-FILLABLE POLYPROPYLENE BOX IN TWO DIFFERENT ASSORTMENTS

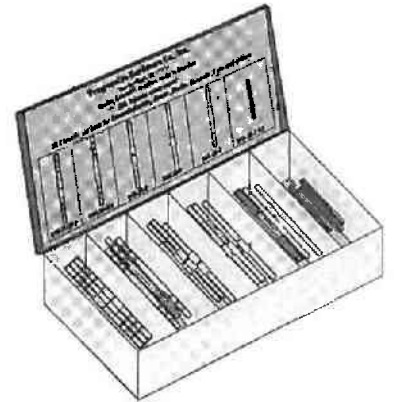

#20 ASSORTMENT - FOR ALL 20 TPI KNOBS (RUSSWIN/COBIN, MARKS, ARROW, NORWALK, YALE, ETC.)

- 6 45-20-S swivel spindle with 3/8" solid centers
- 6 45-20-P swivel spindle with stop pin
- 6 44-20-4 straight spindle
- 6 44-20-4TP straight spindle with tapped holes
- 6 45-20-RTP universal swivel spindle
- 6 46-20-2 5/8 sectional spindle

PG20
189³⁰

#1618 ASSORTMENT - FOR ALL 16 TPI (SARGENT) AND 18 TPI (LOCKWOOD) KNOBS.

- 6 44-16-5 SGT #1632-5 straight spindle
- 6 45-16-S SGT #1635 swivel spindle with 3/8" x 3/8" centers
- 6 46-16 SGT sectional spindle
- 6 44-18-4 1/2 Lockwood #276A straight spindle
- 6 45-18-S Lockwood #293 swivel spindle with 3/8" x 3/8" centers
- 6 46-18 Lockwood sectional spindle

PG1618
290⁸¹

THE DOOR GUARDIAN - for in-swinging doors
No Exposed Mounting Hardware. Door angle mounted with concealed welded studs. Frame mounting screws are covered when door is locked.
Reversible for left or right hand. Drill template provided.

P/N	Description	Finish	Price
PGDG13KB/GP	13" w/knob cut-out	Gold lacquer	24.69
PGDG13KB/BLK	13" w/knob cut-out	Black lacquer	24.69
PGDG13MORT/GP	13" w/mortise cut-out	Gold lacquer	24.69
PGDG13MORT/BLK	13" w/mortise cut-out	Black lacquer	24.69
PGDG13UN/GP	13" w/no cut-out	Gold lacquer	24.69
PGDG13UN/BLK	13" w/no cut-out	Black lacquer	24.69
PGDG13MED/BLK	13" w/Medeco cut-out	Black lacquer	24.69
PGDG13MED/GP	13" w/Medeco cut-out	Gold lacquer	24.69

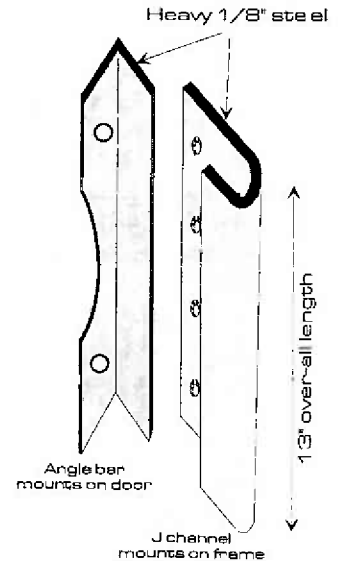

Also available in 30" & 90" size

OVAL PLATE WITH BIT KEY HOLE

1 3/4" x 1 1/8" oval escutcheon.
Packaged two plates/poly bag

Priced per pair

PG75-3 Polished Brass 5.21
PG75-26D Satin Chrome 6.17



SOLID BRASS KEY TAGS

P/N	Dimensions	Approx. Pcs./lb	Price/lb
PG05-L	15/16" x .040	115 pcs/lb	27.16
PG06-T	1" x .025	149 pcs/lb	27.16
PG07	1 1/4" x .040	60 pcs/lb	27.16
PG011	1 3/8" x .060	38 pcs/lb	27.11

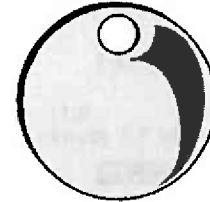

OVAL PLATE WITH THUMB TURN

1 3/4" X 1 1/8" oval escutcheon. Turn has 3/16" square tail.
Packaged one per poly bag

PG76-3 Polished Brass 6.17
PG76-26D Satin Chrome 9.60

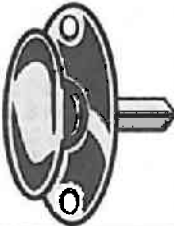

PUSH & PULL PLATES

1001: 3 1/2" x 15" push plate. Full 16 guage (.062") metal. Individually poly bagged. Packed 4/box.

1012: 3 1/2" x 15" push plate with solid brass or aluminum pull with 4 7/8" center to center. Packed with mounting screws and handle thru bolts. Individually poly bagged. Packed 2/box.

P/N	Descrip.	Material	Price
PG1001-3	Push Plate	Solid Brass	16.46
PG1001-32	Push Plate	Stainless Steel	16.46
PG1001-28	Push Plate	Aluminum	9.88
PG1012-3	Pull Plate	Solid Brass	41.15
PG1012-32	Pull Plate	Stainless Steel	30.04
PG1012-28	Pull Plate	Aluminum	24.55

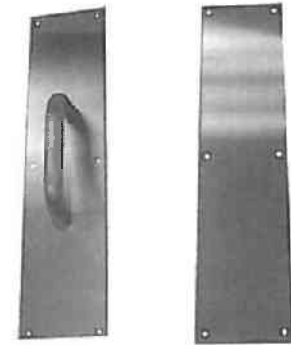

ROUND PLATE WITH THUMB TURN

2 1/4" round escutcheon. Turn piece has 3/16" square tail.
Packaged one per poly bag

PG77-3 6.86
Polished Brass

PG77-26D 10.29
Satin Chrome

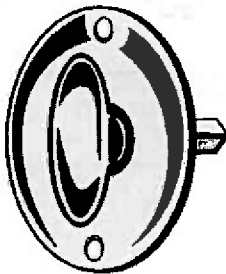

DUMMY CYLINDER

Die cast face with steel back plate. Covers standard cylinder hole.
One per poly bag.

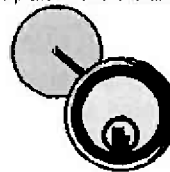

PG195BP Brass Plate 2.06
PG195CP Satin Chrome Plate 2.06

FILLER PLATES

FRAME FILLER PLATE - A.S.A. CUT-OUT

4 7/8" x 1 1/4"
Steel, prime coat
Packaged one per poly bag.

PG74FP
247



FRAME FILLER PLATE

2 3/4" x 1 1/8"
Steel, prime coat.
Packaged one per poly bag.

PG72FP
247



DOOR FILLER PLATE

2 1/4" x 1 1/8"
Steel, prime coat.
Packaged one per poly bag.

PG73FP
233



TUBULAR PASSAGE LATCH

2 3/8" backset plain passage latch. Accepts standard 9/32" square spindle.

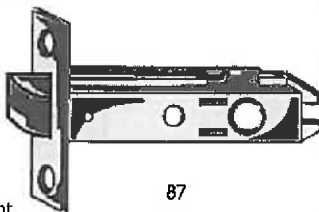

Brass plated front
Packed 12/box

PG87
721

SCAR PLATES

3/16" OD with 1 1/4" hole
Packed one per poly bag

PG198-3 Solid Brass 3.70
PG198-32 Stainless Steel 3.70



3 1/16" x 1 3/4" OD with 1 1/4" hole
Packed one per poly bag

PG199-3 Solid Brass 3.70
PG199-32 Stainless Steel 3.70



MORTISE CYLINDER GUARD PLATE

4" x 10"

Can either replace or go over existing trim (will cover up to 8" escutcheon). 1/4" high cylinder bubble. Supplied with carriage bolts, cap nuts and washers. Extra heavy gauge wrought steel. *Brass on steel finish*

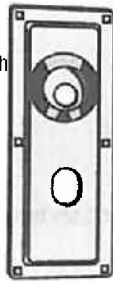

PG1044BP

13⁰³

ADJUSTABLE MORTISE CYLINDER GUARD - 3" x 11"

Cylinder guard replaces existing trim. Adjustable rose allows this plate to fit virtually any mortise lock. Raised bubble covers mortise cylinder and prevents wrenching of cylinder. Supplied with four carriage bolts and sex bolts. Extra heavy gauge wrought steel. *Brass on steel finish*



PG1066BP

14⁴⁰

REPLACEMENT STRIKES

2 1/4" full lip strike

PG73BP Steel, brass plate 2.06

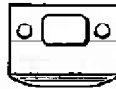

2 3/4" x 1 1/8" T-strike

PG72-3 Solid brass 3.70
 PG72-32 Stainless Steel 3.70



4 7/8" x 1 1/4"

Mortise A. S. A.

PG74-3 Solid brass 7.13
 PG74-26D Satin Chrome 7.13
 PG74BP Brass Plate 3.43



4 7/8" x 1 1/4"

Standard A. S. A.

PG71-3 Solid brass 7.13
 PG71-26D Satin Chrome 7.13

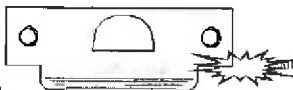

LATCH PROTECTORS FOR OUTSWINGING DOORS

3" x 11" LATCH GUARD

Massive wrought steel or solid brass fits key-in-knob or mortise locks. Complete with carriage bolts, acorn nuts and washers. Individually poly bagged with hanging header.



P/N	Material	Finish	Price
PG1033BP	Steel	Brass	10.29
PG1033DU	Steel	Duranodic	8.92
PG1033SL	Steel	Silver	8.92

2 5/8" x 12" OFFSET LATCH GUARD

Heavy 1/8" steel. 1/4" offset, 1 1/8" backset, 1 7/16" cylinder hole. Protects latch or bolt. Reversible. Supplied with carriage bolts, acorn nuts and washers.



P/N	Material	Finish	Price
PG1077-DU	Steel	Duranodic	10.97
PG1077-SL	Steel	Silver	10.97
*PG1077-WODU	Steel	Duranodic	10.97
*PG1077-WOSL	Steel	Silver	10.97

*w/o hole

2 5/8" x 7" OFFSET LATCH GUARD

Heavy 1/8" steel. 1/4" offset, 1 1/8" backset, 1 7/16" cylinder hole. Protects latch or bolt. Reversible. Supplied with carriage bolts, acorn nuts and washers.

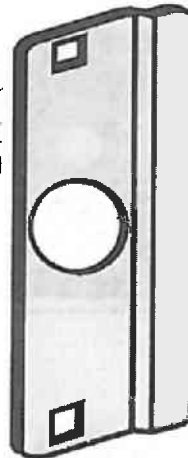

P/N	Material	Finish	Price
PG1088-DU	Steel	Duranodic	8.92
PG1088-SL	Steel	Silver	8.92
*PG1088-WODU	Steel	Duranodic	8.92
*PG1088-WOSL	Steel	Silver	8.92

*w/o hole

2 5/8" x 7" OFFSET LATCH GUARD

This plate has a cutout for up to 3 1/2" roses. 1/4" offset. For deadbolt or key-in-knob locksets.

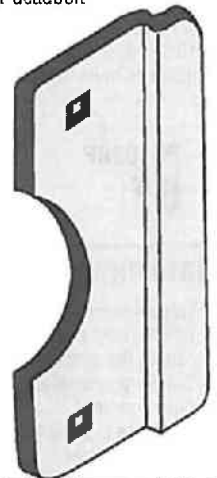

P/N	Material	Finish	Price
PG1099-DU	Steel	Duranodic	8.92
PG1099-SL	Steel	Silver	8.92

EXIT DEVICE, UL LISTED

- Available in aluminum and duranodic painted finishes
- Dogging feature is standard
- Includes all mounting fasteners, strike and filler plates to retrofit almost every existing device
- High visibility black, non-slip, textured touch bar
- Internal activator lever made of cast stainless steel
- Cast stainless steel bolt & deadlatch

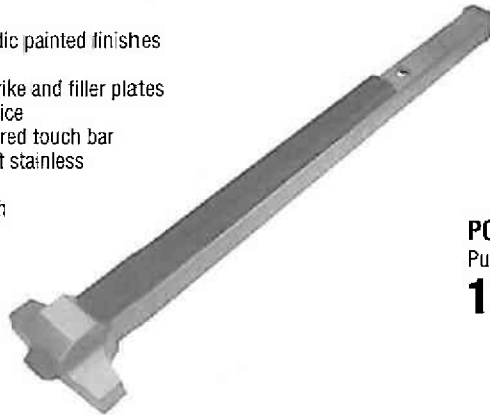

PG560PC-AL

Pull with cylinder hole & sex bolts

123⁵



#560P

PG560P-AL

Pull w/o cylinder hole, with sex bolts

123⁵

P/N	Description	Length	Finish	Price
PG560AL-3	Reversible Device, Exit Only	36"	Aluminum	131.08
PG560AL-4	Reversible Device, Exit Only	48"	Aluminum	144.80
PG560DU-3	Reversible Device, Exit Only	36"	Duranodic	131.08
PG560DU-4	Reversible Device, Exit Only	48"	Duranodic	144.80



PG560LH-26D

Lever Handle, Standard Duty

71³³

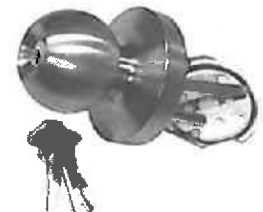

PG560BK-32

Ball Knob, Standard Duty

68⁵⁹

103BP RIM LOCK CYLINDER GUARD

- 5 7/8" X 3" X .090" wrought steel
- Brass plated
- 3/16" center rise for cylinder
- 13/16" diameter key hole
- Includes bolts, nuts, washers

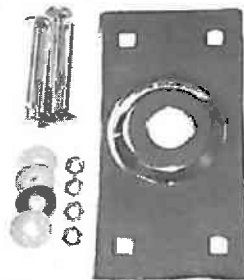

PG103BP

6¹⁷

67 RISING SHIM

For shimming strike used with Jimmy Proof drop bolt locks

- 1" x 4 1/8" x 16 gauge
- Steel, zinc plated
- Packed 10 pcs per poly bag

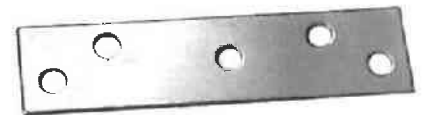

PG67

82¢ each

1010 UNIVERSAL MORTISE LATCH

- Latches reversible for left or right handed doors
- Will fit most existing installations by simply cutting the over-size faceplate
- Solid brass latch and spindle hub
- Cast iron base
- Over-size front is 1" x 6" with four mounting holes
- Includes multi-holed 6" security strike

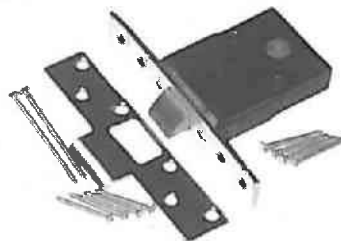

PG1010

71³³

R1000 DROP BOLT FOR REVOLVING DOORS & OTHER APPLICATIONS

- Case is 5 7/8" x 1 3/4" x 1" ingot aluminum
- Stainless steel bolt is 5/8" round
- Bolt protrudes 1 9/16"
- Turn key 900 and bolt drops
- Cylinder w/2 keys included



PGR1000-DU Duranodic

104.25

PGR1000-AL Aluminum

104.25

DOUBLE BAR LOCK

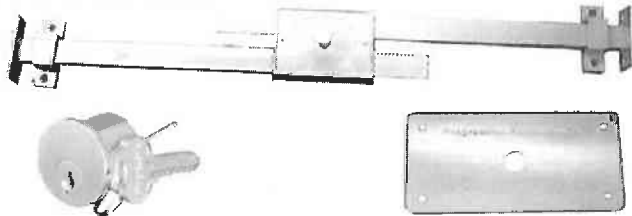

P/N	Fits Door	List
PGDBL-01-32	30"-34"	175.28
PGDBL-01-36	34"-38"	175.28
PGDBL-01-42	40"-44"	175.28
PGDBL-01-48	46"-50"	175.28
PGDBL-BRKT	Bracket for inswing door	13.72
PGDBL-TK	Repl. Knob/Gear Assy	22.63

K700 SERIES DOOR CLOSERS

- UL Listed
- Adjustable latching and closing speeds
- Full rack and pinion for 100% control
- Cast aluminum body - non-handed
- Surface mounted for regular, top jamb or parallel arm (with optional bracket)
- For use on trimline aluminum, wood or hollow metal doors
- 24 hour salt spray tested



P/N	Description	Finish	Price
PGK720-AL	Light to med. duty	Aluminum	59.45
PGK730-AL	Medium Duty	Aluminum	62.50
PGK730-DU	Medium Duty	Duronodic	62.50
PGK730BC-AL	Medium Duty w/back-check	Aluminum	65.54
PGK740-AL	Medium to Heavy Duty	Aluminum	65.54
PGK740-DU	Medium to Heavy Duty	Duronodic	65.54
PGK740BC-AL	Med. to Hvy Duty w/back-check	Aluminum	69.36
PGK740BC-DU	Med. to Hvy Duty w/back-check	Duronodic	69.36
PGK750-AL	Heavy Duty	Aluminum	69.36
PGK750-DU	Heavy Duty	Duronodic	69.36

FOX POLICE LOCK CYLINDER

- Solid brass bar stock cylinder with round tail
- Russwin 1011 keyway
- Two nickel silver keys
- Includes cylinder ring and connecting screws
- Satin Brass finish



PG160FPL
24⁶⁹

JIMMY-PROOF VERTICAL DEADBOLT

- Solid bronze case-bolt-strike
- Hardened drill point screws
- Shutter guard for extra security
- Solid brass cylinder, SE1 keyway, 5 pin w/recessed cylinder collar
- Flat strike standard

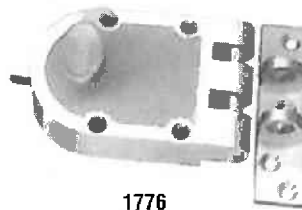

1776



1776AS

P/N	Finish	Strike	Price
PG1776-10	Satin Bronze	Flat	53.34
PG1776-26	Polished Chrome	Flat	64.00
PG1776-3	Polished Brass	Flat	60.96
PG1786-10	Satin Bronze	Angle	54.87
PG1786-26	Polished Chrome	Angle	65.54
PG1786-3	Polished Brass	Angle	62.50

Angle Strikes

PG1776AS-10	Satin Bronze	10.97
PG1776AS-26	Polished Chrome	10.97
PG1776AS-3	Polished Brass	10.97

DOOR INTERVIEWER WITH KNOCKER

A low cost interviewer and knocker that will provide security with functionality. 3 1/2" x 4 1/2" exterior plate is a high pressure zamac casting with an attractive polished brass finish. The glass lens provides a minimum of 1600 of unobstructed view of the area outside the door.



Two slots are available for insertion of an apartment number and tenant name. The interior side of the viewer has a security cover that remains closed unless manually opened. The exterior plate cannot be turned by vandals if properly installed.

PG121-K
20⁵⁸

ROLL DOWN GATE PIN

Roll down gate locking pin. Wrought iron pin with welded head 1/2" round locking pin. 4 3/4" over-all length.



Roll down gate pin

PG1875
7²⁷

HEAVY DUTY CHAIN DOOR GUARD



- Solid brass mounting plates
- Riveted steel roller chain
- Blister carded for secure and easy selling

PG100-3
19²⁰