

### CABLE TRAP

This anti-theft device allows you to secure your "Mouse", "Hand Scanner", "Trackball", "Monitor" and "Keyboard" by trapping the peripheral cable. Simply attach CABLE-TRAP to your computer using an external cover screw and/or our "Super Bond" System. The CABLE-TRAP secures up to five (5) cables -two (2) large and three (3) small. Master Keyed or Keyed Alike options available.

Includes:

- One (1) CABLE-TRAP
- One (1) 3 gram bottle of "Super Bond" adhesive
- Two (2) keys.

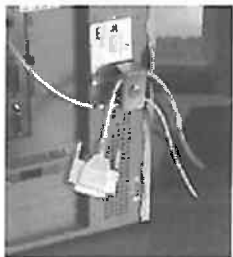

QD-02001  
**31<sup>95</sup>**

### MOBILE SECURITY KIT

Road ready! This universal security system is perfect for office and road use. It's sleek design allows it to be quickly attached or reoved from your computer's built-in security slot. The Mobile Security Kit contains a keyed locking mechanism attached to a 6' steel cable and a travel pouch... all you need to keep your notebook secure.

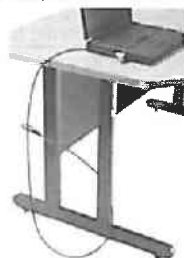

QD-16610  
**39<sup>95</sup>**

### PERSONAL ACCESS-PC POWER LOCK™

The Personal Access PC Power Lock™ device is designed to limit use of your computer by controlling access to the power. Simply install it into the PC's power plug, and instantly a key controls who gets to use the computer. No software and no encryption necessary.

The Personal Access PC Power Lock™ works on ALL PC or MAC desktop and tower computers.

Extra long 6' cable. Once installed, simply turn the system on or off with a key.

QD-15101  
**39<sup>95</sup>**

### FILE-LOK II

FILE-LOK II prevents unauthorized copying of data from your network or hard drive and reduces the chance of viruses by preventing access to the floppy disk drive. The FILE-LOK II secures virtually all laptop, notebook and desktop computers with a 3.5" disk drive. Simply insert into the drive opening and lock in place. FILE-LOK II is made of durable ABS material and is available in both black and putty colors. Master Keyed or Keyed Alike options available.

Includes:

- One (1) FILE-LOK II
- Two (2) keys.

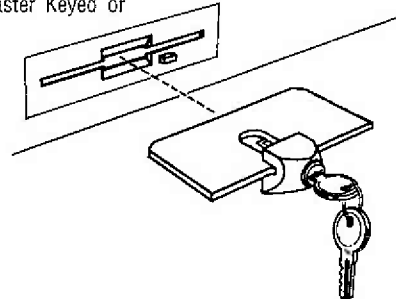

QD-03107      Putty  
**9<sup>95</sup>**

### LOK-KIT II

This revolutionary three (3) plate security system is small, powerfully strong, yet attractive. The distinctive cast metal plates have vinyl surfaces that are activated with Qualtec's "Super Bond" adhesive. This provides a quick easy "industrial strength" bond, with over 700 pounds (318 kgs) of holding strength. The unique low profile, extra strength LOK-KIT II enables the user to not only secure desktop computers and peripherals, but laptops, notebooks, fax machines, copiers, phone systems, audio/visual equipment, etc. This universal kit provides asset control and deters opportunistic theft. Master Keyed or Keyed Alike options available.

Includes:

- Two (2) 1.75" (4.45 cm) round plates
- One (1) .75" x 2" (1.91 cm x 5.08 cm) rectangular plate
- One (1) 5ft. (1.5m) steel cable
- One (1) 3 gram bottle of "Super Bond" adhesive
- One keyed lock with two (2) keys

QD-06413  
**34<sup>95</sup>**

*Bond one of the "Super Bond" plates to each piece of the equipment you want to secure, then weave the cable through each plate and lock in place.*

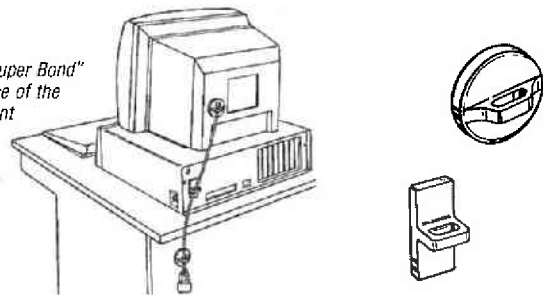

### NOTE-BOOK KIT

NOTE-BOOK is the most complete theft deterrent kit available for "mobile" computers including those with the small security retention slot. This kit secures all notebook and laptop computers including the Apple PowerBook, AST, Compaq, Dell, Digital, H.P., IBM, NEC, Toshiba, Zenith, etc.

QD-06414

**34<sup>95</sup>**

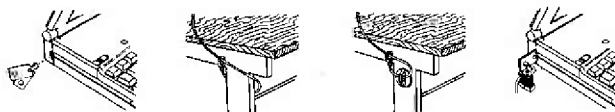

*MICRO-LOK INSTALLATION (For computers with the small security retention slot): Install the MICRO-LOK clip by using a scissor-like action and inserting it in the open position. Next, close the MICRO-LOK and align its two holes. Secure the cable to the work area, using either method shown above and lock the cable to the MICRO-LOK using the keyed lock provided.*

*"SUPER BOND" RECTANGULAR PLATE INSTALLATION: Adhere the rectangular plate to a smooth flat surface on the back side of your notebook. Secure the cable to the work area and lock the cable to the plate using the keyed lock provided.*

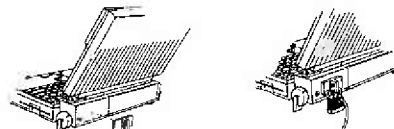

**FILE-LOK III™**  
**Floppy Disk Drive Lock**

High security, heavy-duty disk drive lock - pick and drill resistant with 50,000 key combinations available. Prevents unauthorized copying of data from your network or hard drive and helps prevent viruses. Secures virtually all laptop, notebook and desktop computers with a 3.5" floppy drive. Does not work on Macintosh computers.

Putty color.

QD-03113  
**19<sup>95</sup>**



**UNI-KIT**

With the UNI-KIT you can secure not only computers and peripherals, but fax machines, copiers and audio/visual equipment. The UNI-KIT also protects the internal components of your computer when mounted to a chassis cover screw. This device is ideal for use on leased office equipment where a removable theft deterrent is preferred. Master Keyed or Keyed Alike options available.

*Remove one exterior chassis screw on each piece of equipment that you wish to secure. Take a security housing (UNI-LOK) with the appropriate mounting hardware (included) and attach the housing to the equipment. Weave the cable through the housing and secure either to the accessory plate or around the table leg with the lock provided.*

QD-09416  
**34<sup>95</sup>**

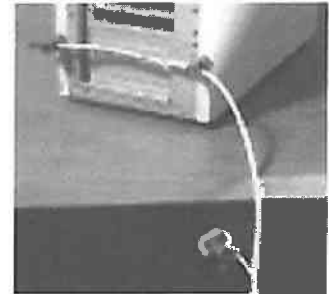

**CHASSIS-LOK**

Protecting internal components from theft and tampering is a growing concern. CHASSIS-LOK is the affordable heavy-duty solution that will save you possibly thousands of dollars in component loss and user down time. CHASSIS-LOK protects the interior of your computer by limiting access to a chassis screw.

CHASSIS-LOK incorporates 2 features that make it the most secure device of its type available. First, by mounting the device to the chassis using our "Super Bond" adhesive, this product is many times stronger than products that just mount using the cover screw. Second, the high security lock is pick and drill resistant with 50,000 different combinations available. For maximum security it is recommended that 2 devices are used per computer. Master Keyed or Keyed Alike options available.

Includes:

- Two (2) CHASSIS-LOKS
- One (1) 3 gram bottle of "Super Bond" adhesive
- Two (2) keys.

*Remove one cover screw on your CPU, apply the "Super Bond" adhesive and position it over the cover screw hole. Replace the cover screw and secure with the CHASSIS-LOK cover.*

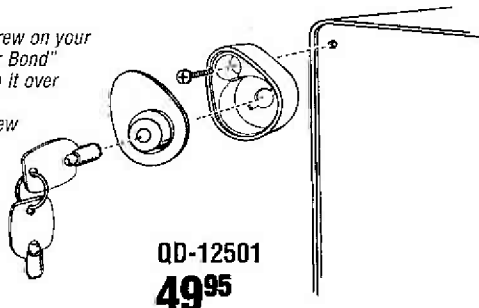

QD-12501  
**49<sup>95</sup>**

**ACCESSORY PRODUCTS**

These general purpose accessories can be used to expand LOK-KIT I, LOK-KIT II, NOTEBOOK KIT AND UNI-KIT II.

**Cable-Lok** Seven bundles x 19 strands of steel braided aircraft style cable. Cable size is 5/32" vinyl coated to 7/32" with eyelet fitting on one end and bail fitting on the other.

P/N	Model	Length	Price
QD-04115	6A	5 ft.	13.95
QD-04118	7A	7 ft.	15.95

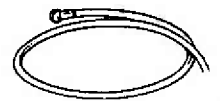

**Accessory Plates (Lok-Kit II)**

"Super Bond" plates can be used on any flat surface to secure either additional peripherals or as an anchoring point to the work station.

Includes:

- One 1.75" (4.45 cm) Round Plate,
- One .75" x 2" (1.91 x 5.08 cm) Rectangular Plate
- One (1) 3 gram bottle of "Super Bond" adhesive

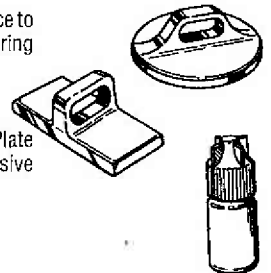

QD-05403  
**14<sup>95</sup>**