

DOOR CLOSER

COMBINED BARRIER FREE AND DELAYED ACTION

This combined barrier free and delayed action door closer presents a ten year warranty, meets ANSI Grade 1 A-156.4 standards. These closers are specifically designed with the physically impaired in mind, and help meet ADA standards, while easing access for the disabled. Adjustable from 1/2 to 4. Non-handed

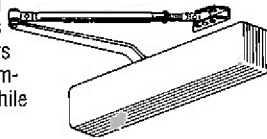

Barrier Free: Allows reduction in spring power so that door opening is easier for the disabled.

Delayed Action: Slows door closing so passage is eased for people with disabilities.

PACB900AL Aluminum **144.45**

PACB900DU Duranodic **144.45**

Spring Power Adjustment: ADA compliant at lower setting. Adjustable from 1-6.

PA900BCAL Aluminum **130.07**

PA900BCDU Duranodic **130.07**

DOOR CLOSER

RESIDENTIAL

These door closers are universal and reversible for LH or RH doors.

Overall body size is 6" long and 2 1/2" deep by 2 1/4" high, with a cast body and high impact plastic casing.

Clamshell Pack

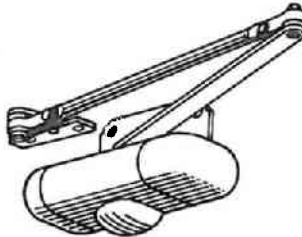

Light Duty-Doors Up To 66 lbs.

PA00050 Ivory **66.88**

PA00051 Chocolate **66.88**

Heavy Duty-Doors Up To 140 lbs.

PA00052 Ivory **82.86**

PA00053 Chocolate **82.86**

TEE HINGE

Heavyweight Tee Hinge is carded, one pair per card, complete with screws. 8" long.

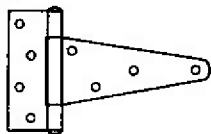

PL06268G
 Galvanized w/
 Solid Brass Pin
24¹⁴

**DOOR CLOSER
 CONTRACTOR QUALITY**

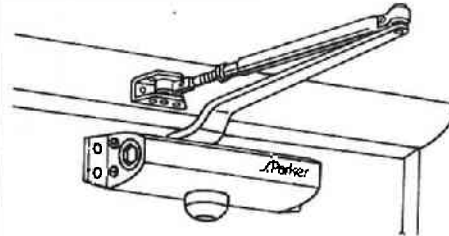

10 Year Warranty

The 950 closer features 2 speed controls for closing and latching. Non-handed and using the same template as many other national brands, including the Parker 500, Yale 50 and Norton 1600, this door closer is a rack and pinion action door closer with all temperature hydraulics in an aluminum housing. Separate controls adjust, at any time, both closing and latching speeds.

Heavy Duty (48" Wide Interior, 36" Wide Exterior)

PA954AL Aluminum **86.15**

PA954BCAL Aluminum, w/Back Check **93.53**

PARALLEL ARM CLOSER MODELS

Medium Duty (32" Wide Interior, 27" Wide Exterior)

PAPA952AL Aluminum **82.46**

PAPA952DUR Duranodic **82.46**

Medium/Heavy Duty (36" Wide Interior, 30" Wide Exterior)

PAPA953AL Aluminum **92.31**

PAPA953DUR Duranodic **92.31**

Heavy Duty (48" Wide Interior, 36" Wide Exterior)

PAPA954AL Aluminum **95.98**

PAPA954DUR Duranodic **95.98**

GARAGE DOOR LOCKING HANDLES

T-shaped handle has a square shank, and is chrome plated. Works well in new or replacement situations.

L-shaped handle works on RH or LH garage doors. Chrome plated, works well in new or replacement situations.

PA05364
12⁵⁴

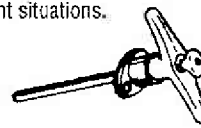

PA05365
13⁴⁴

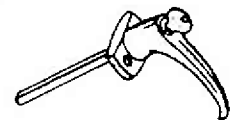

DOOR PULL

Designed for wood screws. Overall length 7 1/8", with the pull handle 5 7/8" center to center. Projection 2 1/8". Bases are 2" in diameter.



PAP531AL
11³²

JIMMY PROOF SOLID BRONZE LOCK

Five pin Segal 1022 keyway. Reversible. Flat strike. Clamshell pack.

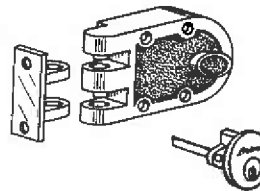

PA07133
49⁹⁹

NIGHT LATCH

Bronze enamel finish, clamshell packed.

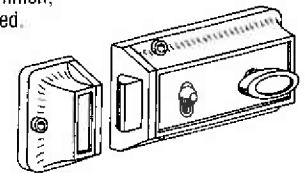

PA22430
22⁸²

BALL BEARING FULL MORTISE TEMPLATE HINGE

These hinges fit snugly and trimly in wood or hollow metal doors with pressed metal or wood jambs. Hinges are loose pin and are fully swaged for smooth operation and long life. Ball bearing hinges provide smoothest operation even under heavy service conditions. Hinges are packed with all machine screws and half wood screws. Type FF-H-116A

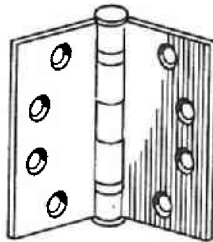

4 1/2" x 4 1/2"

PAB1279PC4H	Prime Coat Grey Finish	12.28/pr
PAB1279DCH4H	Dull Chrome Plated	18.45/pr

PLAIN BEARING FULL MORTISE TEMPLATE HINGE

These hinges fit snugly and trimly in wood or hollow metal doors with pressed metal or wood jambs. Hinges are loose pin and are fully swaged for smooth operation and long life. Hinges are packed with all machine screws and half wood screws. Type FF-H-116A

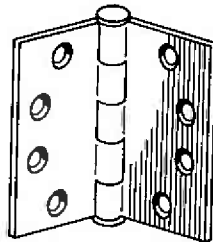

4 1/2" x 4 1/2"

PA1279PC4H	Prime Coat Grey Finish	11.17/pr
PA1279DCH4H	Dull Chrome Plated	14.89/pr

DOOR CLOSER HINGES

Listed by UL for use on labeled fire doors. These hinges use a dependable coil spring design and fit into a standard 4 1/2" x 4 1/2" mortise template. May be used with ball bearing hinges on the same door. An anti-friction bearing handles both vertical and horizontal loading, and the spring meets the toughest requirements. Spring tension is adjustable and can be changed before or after installation. The hinge is torque adjustable, using a setscrew, for closing speed and comes with a wrench, adjusting pin and directions. Hinges are packed with all machine screws and half wood screws.

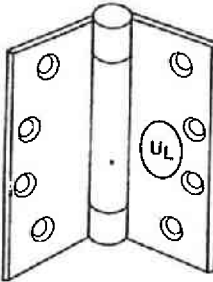

PAUL1278PC	Spring Hinge Top Adj.	Prime Coat	40.18/ea
PAUL1278DCH	Spring Hinge Top Adj.	Dull Chrome Plated	44.64/ea

HALF SURFACE HINGE

Half surface template hinges mount on the surface of the door, and are mortised into the jamb. They work well in applications where the door has a normal hinge bearing surface—the edge—that won't hold screws. These half-mortise template hinges fit applicable, matching template-guided recesses in the jamb.

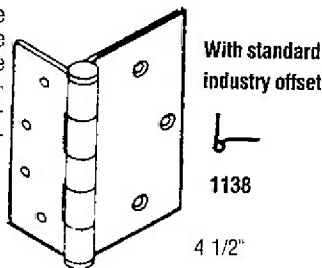

PAB1138PC4HN	
33⁰²/pr	

SINGLE ACTION SPRING HINGES

These single action spring hinges work well to close residential and commercial doors, and are adjustable. The half-surface version 2019 with a mortise jamb leaf of 4 1/2" and a surface door leaf of 5 1/2", fitting standard dimension templates, while the 2020-6 and 2020-7 are non-template styles that mount flat to the door, and are mortised into the job.

HALF SURFACE TEMPLATE PRIME COAT
4 1/2" Mortise Jamb Leaf; 5 1/2" Surface Door Leaf

PA2019
35⁹¹/pr

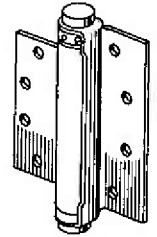

HALF SURFACE NON-TEMPLATE PRIME COAT

PA20206	6"	36.92/pr
PA20207	7"	56.56/pr

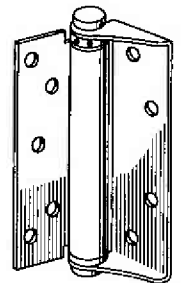

SINGLE ACTION SPRING HINGE
N. Y. C. HOUSING AUTHORITY APPROVED

The 2029 series hinges provide tamper resistant spring action to suit N.Y.C. Housing Authority requirements. To meet those requirements, the top button on the hinge is not removable, so that the spring cannot be removed or tampered with. *Non-Template, Prime Coat*

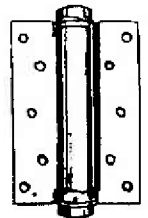

PA2029C6	6"	24.25/pr
PA2029TH6	6" NYCHA Approved	25.01/pr

DOUBLE ACTION SPRING HINGES

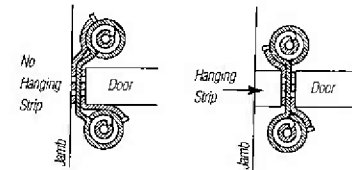
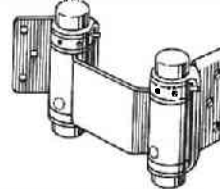

Double acting spring hinges give closing action from either direction. Energy is stored in the spring as the door is opened, and closed the door as it is released. Spring tension is adjustable at any time. Models are available for doors with and without hanging strips, and sizes are made to operate door weights, per pair, from 25 lbs.-70 lbs., in thicknesses ranging from 3/4" to 1 3/4" (not all thicknesses work with all models).

PA070SPB3	Light/Medium Duty	3" Sprayed Brass	22.99/pr
PA070SPB4	Medium Duty	4" Sprayed Brass	26.44/pr
PA070SPB5	Medium/Heavy Duty	5" Sprayed Brass	37.94/pr
PA070SPB6	Heavy Duty	6" Sprayed Brass	59.14/pr

RESIDENTIAL GRADE 3 LEVERSET

The Somerset is a contemporary lever that has a straight lever handle with a 2" return. The entry lever features a deadlatch for added security. Each lever set has an adjustable backset 2 3/8" to 2 3/4". Door thickness is 1" to 1 1/4".

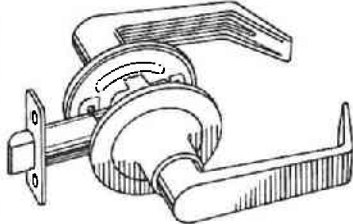

The entry set has a ball knob on the keyed side. Standard keyway is KW1. *Clamshell package.*

PA98110	Lever/Ball Entry	Polished Brass	40.00
PA98120	Lever Passage	Polished Brass	36.83
PA98130	Lever Privacy	Polished Brass	37.84

TUBULAR DEADBOLT

Single cylinder, tubular deadbolt. Adjustable backset, 2 3/8" - 2 3/4". Solid brass bolt, with a hardened steel core that rotates to make hacksawing almost impossible. Bolt throws 1". Pin tumbler cylinder, with KW1 keyway. *Clamshell pack*

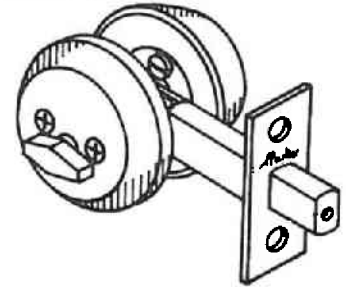

PA91130	Polished Brass	32⁶¹
PA91132	Stainless Steel	30¹⁵

BALL KNOB LOCKSET

All locksets have adjustable 2 3/8" to 2 3/4" backsets. The locksets fit doors 1 1/8" to 1 3/4" thick. Standard keyway is KW1. For use with wood or hollow metal doors.

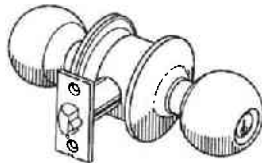

PA91510	Entry	Polished Brass	33.07
PA91520	Passage	Polished Brass	25.68
PA91530	Privacy	Polished Brass	27.10

INSIDE MORTISE LOCKSET

Excellent for renovation and remodeling work, with a 2 3/8" backset and a deadbolt that is 7/8" x 5/16" using a 1/2" throw. The face plate is 7/8" x 3 7/8". Escutcheon is 2 1/4" x 7 1/16" with 2 1/8" diameter knobs. Includes 2 bit keys. Polished brass. *Clamshell pack*

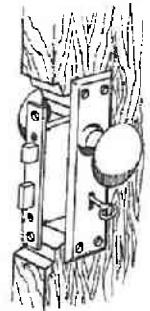

PA36000	24⁶⁹
----------------	------------------------

TULIP KNOB LOCKSET

All locksets have adjustable 2 3/8" - 2 3/4" backsets. The locksets fit doors 1 1/8" to 1 3/4" thick. Standard keyway is KW1. For use with wood or hollow metal doors.

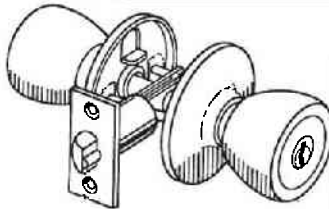

PA91110	Entry	Polished Brass	31.72
PA91150	Passage	Polished Brass	24.31
PA91160	Privacy	Polished Brass	25.74
PA17310	Entry	Polished Brass	23.90

GRADE 2 CONTRACTOR QUALITY HEAVY DUTY CYLINDRICAL LEVERSET

- Two step rose
- Cold rolled steel housing
- Reversible, non-handed
- Fits doors 1 3/8" - 1 3/4" thick
- 2 3/4" backset UL listed latch
- 1 1/4" x 4 7/8" ANSI strike
- 6 pin solid brass SC1 keyway. Ilco 1145, keyed to 5 pins

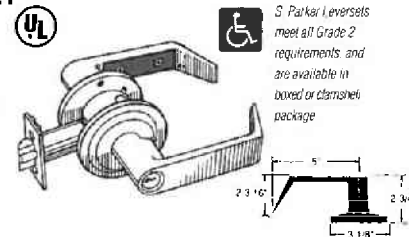

CRYSTAL CUT GLASS DOORKNOBS

2" Knob Clamshell Pack. Knobs come complete with hardened steel spindle.

PA05363
12³⁶



SOLID BRASS ROUND DOORKNOBS

2 1/4" Solid Polished Brass Knob Clamshell Pack. Knobs come complete with hardened steel spindle.

PA05360
13⁷¹

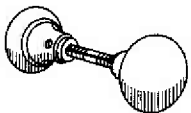

PASL7160A03KD	Entrance	Polished Brass	106.49
PASL7160A26DKD	Entrance	Satin Chrome	106.49
PASL7160D03	Storeroom	Polished Brass	106.49
PASL7160D26D	Storeroom	Satin Chrome	106.49
PASL7160N03	Passage	Polished Brass	97.11
PASL7160N26D	Passage	Satin Chrome	97.11
PASL7160P03	Privacy	Polished Brass	97.81
PASL7160P26D	Privacy	Satin Chrome	97.81
PASL7160R03	Classroom	Polished Brass	111.93
PASL7160R26D	Classroom	Satin Chrome	111.93

**NARROW STILE LOCKS
NARROW STILE LATCH WITH ALL
METAL LATCHES**

- Face Plate: 1" x 6 7/8"
- Backsets: 31/32" or 1 1/8"
- Supplied less cylinders. Uses standard 1" mortise cylinder.

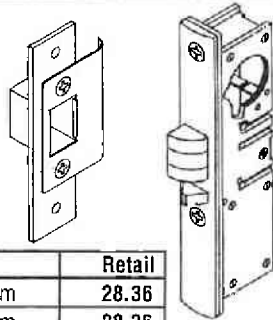

P/N	Description	Finish	Retail
PAN6201ALL	31/32" LH	Aluminum	28.36
PAN6201ALR	31/32" RH	Aluminum	28.36
PA6201ALL	1 1/8" LH	Aluminum	29.65
PA6201ALR	1 1/8" RH	Aluminum	29.65
PAN6201DURL	31/32" LH	Duranodic	28.36
PAN6201DURR	31/32" RH	Duranodic	28.36
PA6201DURL	1 1/8" LH	Duranodic	29.65
PA6201DURR	1 1/8" RH	Duranodic	29.65

HEAVY DUTY DEADLATCH

- Backset: 1 1/2"
- Finish: Aluminum
- Supplied less cylinders. Uses standard 1" mortise cylinder.

PA6301ALL	LH	35.82
PA6301ALR	RH	35.82

PUSH/PULL HANDLES

This well designed paddle was made specifically to operate trouble free with any narrow stile latch. It has 2 heavy duty compression springs, 2 reversible non-handed gear blocks that move in precisely engineered channels. Complete with mounting hardware and cam plug. Replaces popular industry models and is interchangeable with Adams Rite.

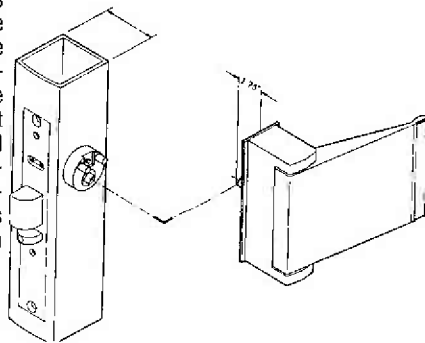

P/N	Description	Finish	Retail
PAPUSH6201ALL	Left Hand	Aluminum	62.48
PAPUSH6201ALR	Right Hand	Aluminum	62.48
PAPUSH6201DURL	Left Hand	Duranodic	62.48
PAPUSH6201DURR	Right Hand	Duranodic	62.48
PAPULL6201ALL	Left Hand	Aluminum	62.48
PAPULL6201ALR	Right Hand	Aluminum	62.48
PAPULL6201DURL	Left Hand	Duranodic	62.48
PAPULL6201DURR	Right Hand	Duranodic	62.48

BAR BOLT NARROW STILE

- Face Plate: 1" x 6 7/8"
- Backset: 1 1/8"
- Supplied without cylinders

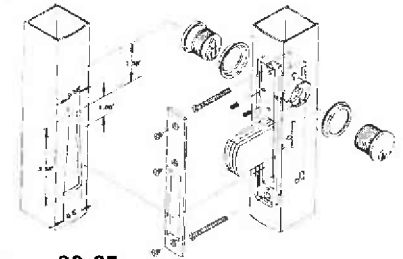

PA6202LCAL	Aluminum	29.65
PA6202LCDUR	Duranodic	29.65

HOOK BOLT NARROW STILE DEADBOLTS

- Face Plate: 1" x 6 7/8"
- Backset: 1 1/8"

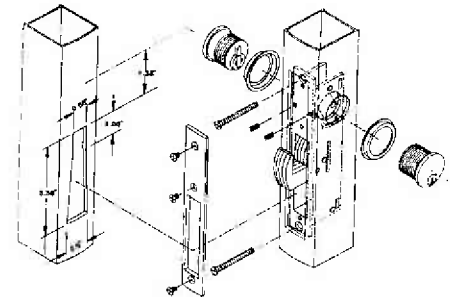

P/N	Description	Finish	Retail
PAN6202HAL	w/cylinders	Aluminum	50.05
PAN6202HDUR	w/cylinders	Duranodic	50.05
PA6202HLCAL	w/o cylinders	Aluminum	28.36
PA6202HLCDUR	w/o cylinders	Duranodic	28.36

LEVER HANDLE WITH CAM PLUG

LP6201 lever handle and cam plug sets are available individually to fit narrow stile latches. Available in both aluminum and duranodic finishes, the sets are handed for left and right uses.

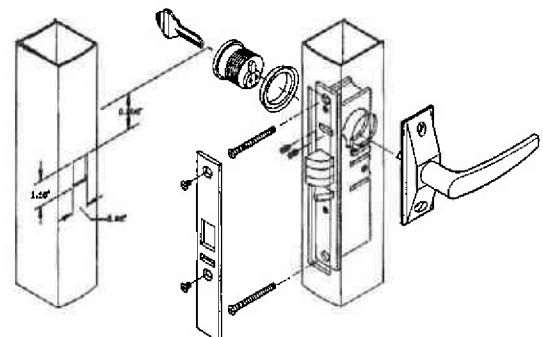

P/N	Description	Finish	Retail
PALP6201ALL	Left Hand	Aluminum	28.36
PALP6201ALR	Right Hand	Aluminum	28.36
PALP6201DURL	Left Hand	Duranodic	28.36
PALP6201DURR	Right Hand	Duranodic	28.36

SCREEN DOOR LATCHES

S.Parker's 64000 series push button latch for storm doors has an "I" style tie-down handle, and needs only three 1/4" holes for installation. The inside latch has an anti lockout feature. The latch works on outswinging doors from 7/8" to 1 1/4" thick, and comes in a clamshell pack.

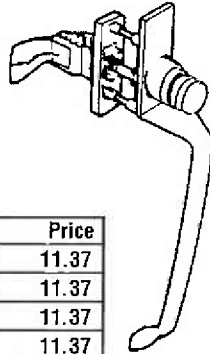

P/N	Hole Spacing	Keyed	Finish	Price
PA64000	1 1/2"	No	Aluminum	11.37
PA64001	1 1/2"	No	Black	11.37
PA64100	1 3/4"	No	Aluminum	11.37
PA64101	1 3/4"	No	Black	11.37
PA64090	1 1/2"	Yes	Aluminum	14.01
PA64091	1 1/2"	Yes	Black	14.01

"W" STYLE PUSH-BUTTON LATCH

The S.Parker 64200 series of W type push-button storm door latches feature 1 3/4" mounting hole spacing, installation through three 1/4" holes, and acceptance of door thicknesses from 7/8" to 1 1/4". The latches have an anti-lockout feature, and work on outward swinging doors.

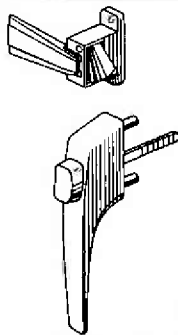

P/N	Finish	Price
PA64200	Aluminum	11.37
PA64201	Black	11.37

"W" STYLE PUSH-BUTTON LATCH WITH WRAP AROUND HANDLE

These latches feature a wrap-around exterior handle, anti-lockout, 1 3/4" mounting hole spacing, and installation in three 1/4" holes. The latch for outward swinging doors that are 7/8" to 1 1/4" thick. *Clamshell pack*

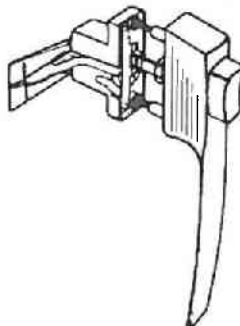

P/N	Finish	Price
PA64300	Aluminum	11.37
PA64301	Black	11.37

"I" STYLE KNOB LATCH

The "I" style knob latch for storm and screen doors takes 3" mounting hole spacing, using three 1/4" holes. It works on all outward swinging doors from 7/8" to 1 1/4" thick. *Aluminum, clamshell pack*

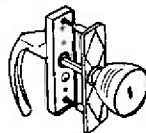

P/N	Keyed	Price
PA64400	No	17.06
PA64490	Yes	19.91

SCREEN DOOR STRIKE

Replace worn or damaged strikes with this quality replacement. *Carded*

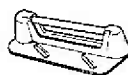

PA66000	Aluminum	2.39
---------	----------	------

SLIDING DOOR LOCKS

For showcase and cabinet doors. Polished chrome die cast alloy, with disc tumbler cylinder. Locking bars are chrome plated steel, and adjust for length. "T" series are mirror polished chrome, while "F" series are polished chrome steel.

P/N	Door Thick.	Key No.	Price
PA090T131	1/4"	131	30.96
PA090TKD	1/4"	KD	30.96
PA090F127	1/4"	127	6.54
PA090F131	1/4"	131	6.54
PA090FKD	1/4"	KD	6.54

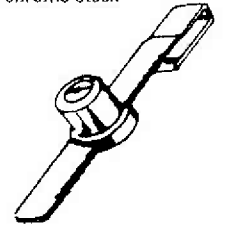

SHOWCASE LOCK

For showcase doors, S.Parker's showcase locks are die cast alloy, with a polished chrome finish. The disc tumbler cylinder has 2 keys, and the lock fits glass doors to 5/16" thick. The locking bar is chromed steel

PA050KA	13.80
PA050KD	13.80

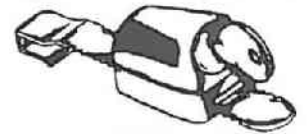

TRAVEL/MULTI-PURPOSE LOCK

The travel/multi-purpose lock fits most drawers and doors, and needs no permanent attachment to provide security. The lock is chrome plated over die cast alloy, with a chrome disc tumbler cylinder, adjustable chromed steel locking bar and back plate.

PA080KA	15.00
---------	-------

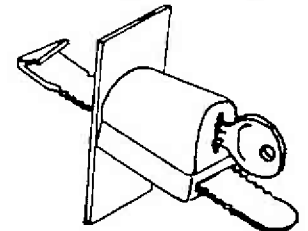

SLIDING DOOR LOCK

- Mounting plate: 1 7/8" x 1 1/16"
- Door thickness: 7/8"

Polished Brass

Used for showcases, cabinets and sliding wood doors.

PA2286PBA
16¹⁰

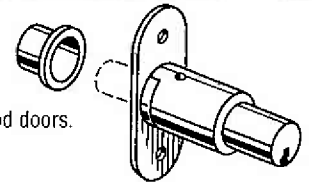

SOLID BRASS SLIDING DOOR LOCK

Provide great quality, appearance and durability.

- Door thickness: 7/8"
- Pin tumbler cylinder
- Mounting plate: 1 7/8" x 1 1/16" x 9/32"
- KA33

PA2290PB33
12⁶⁴

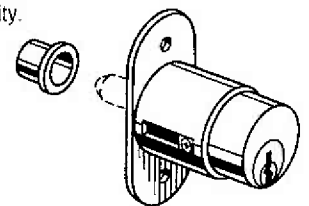

"JAWS"

Solid brass padlocks provide a rare five way deterrent to security problems. The case hardened shackle spins, which means file and saw teeth cannot get a grip for cutting; the shackle is set into the lock body so that there's no room for a bolt cutter to operate. Comes with a 5 pin tumbler, key retaining cylinder. 2"

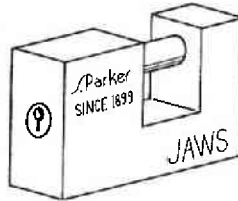

PA00569 KD, Clamshell **20.47**

"BANK VAULT™"

Using a replaceable solid brass pin tumbler, this padlock is double locking, and has heavy chrome plating. KD or KA. 2 1/2" case. Accepts American plug. Uses Ilico 1045 blank.

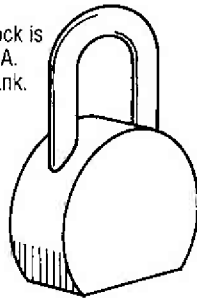

PL04761 **PL04761KA**
16³⁵ **15⁶⁰**

FIXED STAPLE SAFETY HASP

Safety hasps provide good security under many conditions. The hasp is carded and comes complete with all screws.

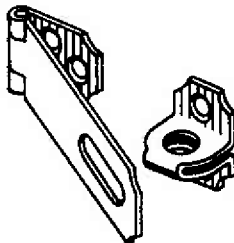

PA11225	2 1/2"	2.17
PA11235	3 1/2"	2.93
PA11245	4 1/2"	3.44
PA11206	6"	5.26

HASP LOCK

- Chrome Plated Steel
- 4 1/2" Long
- Carded, with all required screws

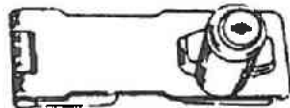

PA17264 **PA17264KA**
11⁷⁵ **11⁰⁰**

WEDGE WINDOW LOCK

The wedge window lock screws onto the upper sash and is used to lock windows partially open for ventilation, and closed enough to prevent easy entry. Complete with screws, the brass plated 76300 comes 2 to a card.

PA76300
3²³

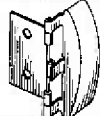

KEYED SASH LOCK

Cam action sash lock. Brass plated. Carded

PA71130
10⁵⁴

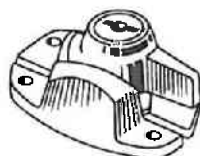

KEYED PATIO DOOR LOCKS

Now sliding patio doors can easily be secured with any of these heavy duty locks. They prevent prying and each lock comes with tamper resistant screws which are almost impossible to remove with a screwdriver.

Standard
Chrome plated finish.
Carded

PA21930
5⁰⁵



Heavy Duty
Carded

PA05314
Aluminum
Finish
18²²

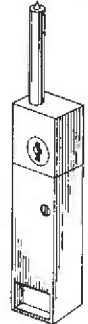

DOOR VIEWERS

Combination Door Chime and Viewer

The non-electric chime easily fits almost all doors, and saves worrying about power problems. The 180° viewer aids security. There are frames for apartment number and resident's name. The 1602 comes in 2 finishes, polished brass and dull chrome.

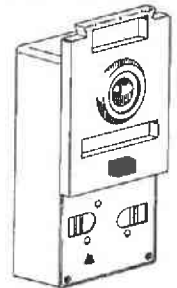

PA1602 Polished Brass Metal **39.64**
PA1602DCH Dull Chrome **41.39**

160°
For doors 1 1/8" - 2 3/8" thick. 1/2" diameter.
PAR1606 Polished Solid Brass Boxed **3.94**
PA05333 Polished Solid Brass Carded **4.93**

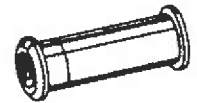

190°
For doors 1 3/8" - 2 1/8" thick. 9/16" diameter.
PA05334 Polished Solid Brass Carded **6.54**

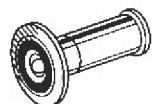

VENTILATING WINDOW LOCK

The 77300 ventilating window lock works on all double hung windows, locking the window open to allow ventilation. Complete with screws, there are 2 brass plated lock on each card.

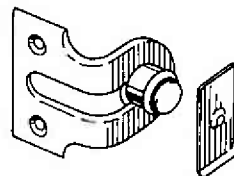

PA77300
8⁶⁸

DOOR INTERVIEWER

The 1601 door interviewer has a 190° angle of view, and fits doors from 1/8" to 2 1/8" thick. There are frames for a number and name on the polished brass plated item.

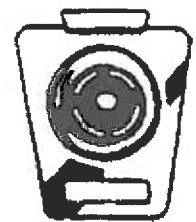

PA1601
26⁴⁴

CHAIN DOOR FASTENERS

SOLID BRASS

Boxed, packed with mounting screws
 Polished chrome finish.

PA1598PCH
9¹⁰

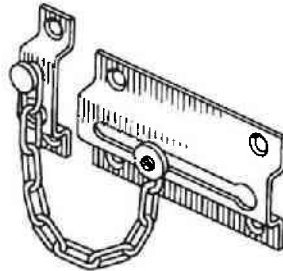

STEEL

Carded

PA26300	Brass Plated	2.88
PA1600PCH	Chrome Plated	4.91

KEYED CHAIN DOOR LOCK

Polished brass plated. *Carded*

PA21030
16⁵⁰

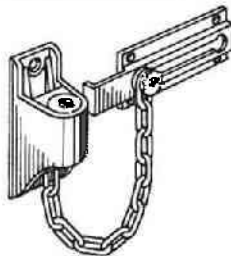

KICK DOWN LEVER TYPE DOOR HOLDER

Cast solid brass. Packed with mounting screws.
Poly bagged

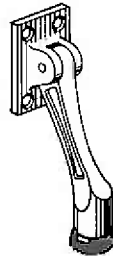

PAB1135SPAC	Sprayed Aluminum	22.53
PAB1135SPBC	Sprayed Brass	22.53

PADLOCKABLE BARREL BOLT

Extra heavy duty. Notches lock the bolt securely in open or closed position. Comes with universal & surface mount strike.

P/N	Length	Finish	Pack	Price
PA2625	5"	Zinc	Polybag	8.77
PA44205	5"	Zinc	Carded	8.30
PA2628	8"	Zinc	Polybag	7.81
PA44208	8"	Zinc	Carded	10.03

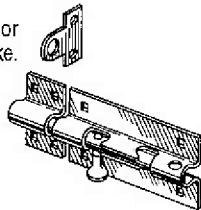

STANDARD WEIGHT BARREL BOLT

Suitable for windows, average and lightweight doors, and cabinets. Complete with screws and surface strike.

P/N	Length	Finish	Pack	Price
PA41302	2"	Brass	Carded	1.85
PA41325	2 1/2"	Brass	Carded	1.93
PA41303	3"	Brass	Carded	1.97
PA41304	4"	Brass	Carded	3.05
PA41305	5"	Brass	Carded	3.09
PA41306	6"	Brass	Polybag	3.23

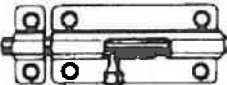

EXTRA HEAVY BARREL BOLT

Made of brass plated steel. Positive locking is created with notches on the body of the barrel. Provide excellent security for screens, doors and windows.

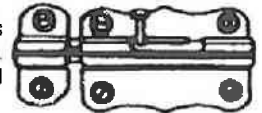

P/N	Length	Finish	Pack	Price
PA42303	3"	Brass	Carded	2.22
PA42304	4"	Brass	Carded	2.47
PA42305	5"	Brass	Carded	3.22

SURFACE BOLTS

Made of extruded brass. Polished brass finish.

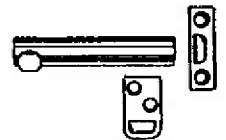

P/N	Length	Pack	Price
PA05384	4"	Carded	6.99

BLACK SQUARE BOLT

Black square bolts are very useful for gates, barns and other outbuilding doors.

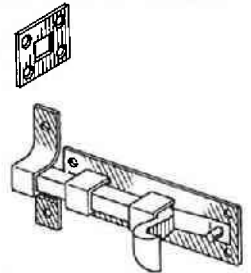

P/N	Length	Pack	Price
PA43106	6"	Carded	7.69

8" HEAVY DUTY SURFACE BOLT

Mounting screws are totally concealed for extra security. It is jimmy resistant. A mortise strike is included for the top of a jam or reverse beveled door.

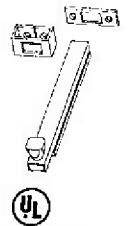

PA2095DCH
29²⁴

LEVER FLUSH BOLTS w/ROUNDED CORNERS

These flush bolts have 12" rods, and rounded corners. The bolts are 15/16" wide x 5 5/8" long. With either a 1/8" or 1/4" offset, the bolts are available in aluminum or duranodic finishes, for installation on aluminum store front doors.



P/N	Offset	Finish	Price
PAR198ALE	1/8"	Aluminum	11.49
PAR198DURQ	1/4"	Duranodic	11.49
PAR198DURE	1/8"	Duranodic	11.49

REVERSIBLE RIM TYPE CONTRACTOR QUALITY TOUCH BAR PANIC DEVICE - GRADE 1

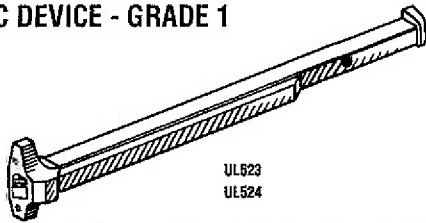

UL623
UL524

Horizontal reversible, rim type touch bar exit devices UL series fit a 24" to 36" wide door, and can be used with a cylinder, keyed ball knob or keyed lever, or pull. Packed with latch and strike filler plates.

Aluminum or duranodic finish

- Deadlatching
- Non-handed for use on right or left opening doors
- Easy to install new or replacement
- Complete with rim strike latch, shim, fasteners, mounting templates and easy to follow instructions
- Vertical panic device for double door installations
- Vertical unit can be cut to size. Fits doors up to 36" x 90". Minimum door size is 25"
- Vertical touch bar is used with the UL520 horizontal device

PAUL523-AL	25"-36" Wide	Aluminum Finish	203.20
PAUL523-DU	25"-36" Wide	Duranodic Finish	203.20
PAUL523-AL	25"-48" Wide	Aluminum Finish	224.85
PAUL523-DU	25"-48" Wide	Duranodic Finish	224.85

REVERSIBLE RIM TYPE CONTRACTOR QUALITY TOUCH BAR PANIC DEVICE - GRADE 1

Horizontal reversible, rim type touch bar exit devices UL series fit a 24" to 36" wide door, and can be used with a cylinder, keyed ball knob or keyed lever, or pull. Packed with latch and strike filler plates.

Aluminum or duranodic finish

- Deadlatching
- Non-handed for use on right or left opening doors
- Easy to install new or replacement
- Complete with rim strike latch, shim, fasteners, mounting templates and easy to follow instructions
- Vertical panic device for double door installations
- Vertical unit can be cut to size. Fits doors up to 36" x 90". Minimum door size is 25"
- Vertical touch bar is used with the UL520 horizontal device

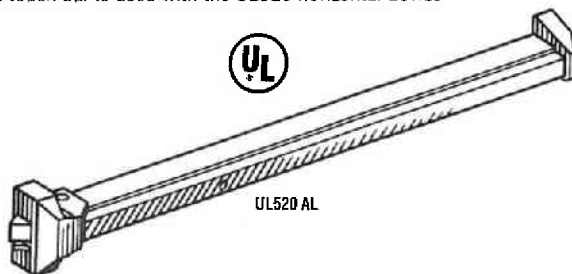

UL520 AL

PAUL520-AL	Aluminum	201.00
PAUL520-DU	Duranodic	201.00

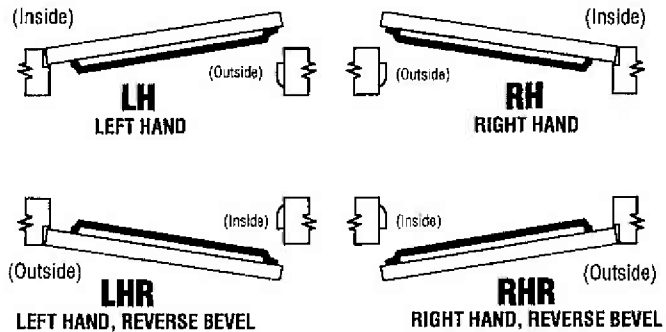

PATIO BAR GUARD

Provide quality security for most sliding glass doors. The 48" long bar of the guard is easily cut to the exact length needed. Made of square aluminum tubing, the patio bar guard folds out of the way when not in use. Made of extra strong 5/8" extruded aluminum tubing. Works on doors that have the sliding panel on the inside or outside.

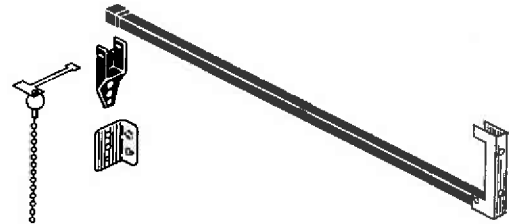

PA20828	Aluminum Finish	14.89
----------------	-----------------	--------------

UNIVERSAL EXIT DEVICE OUTSIDE TRIM

For S.Parker and other exit devices. *Not to be used with UL550 mortise exit device, above.*

Ball Knob Keyed Lock-stainless steel

PAKL520SS	Entry	69.59
PADKL520SS	Storeroom	82.25

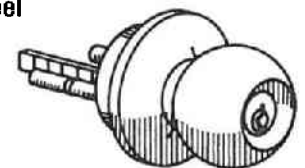

Lever Keyed Lock-US26D

PALL520DCH	Entry	104.89
PADLL520DCH	Storeroom	116.40

